

The influence of QoS routing on the achievable capacity in TDMA based Ad hoc wireless networks

S. Sriram · T. Bheemarjuna Reddy ·
C. Siva Ram Murthy

Published online: 30 August 2008
© Springer Science+Business Media, LLC 2008

Abstract The issue of providing Quality of Service (QoS) guarantees in an Ad hoc wireless network is a very challenging problem. In this paper, we make the following contributions: (i) analytically derive bounds for the end-to-end call acceptance rate using existing queueing theory methods, (ii) study the impact of the routing scheme on the end-to-end call acceptance rate, and (iii) propose a differentiated services scheme for deterministically providing QoS guarantees. Unlike the existing studies which analyze the transport capacity, we focus on the end-to-end call acceptance. The framework that we assume is that of a TDMA based Ad hoc wireless network. The routing scheme employed influences the end-to-end call acceptance of the network. The metrics that we consider are the call acceptance probability and the system saturation probability (i.e., the probability that the network is in a state in which every new call is rejected). We derive general bounds on the call acceptance and the system saturation for the case of differentiated-classes of users in the network. These bounds indicate the number of calls of the highest priority class that can be admitted into the network. Simulation studies were carried out to study the effect of

load, hopcount, and the influence of the routing protocol on the call acceptance. The increase in the call acceptance rate with the introduction of load-balancing highlights the importance of load-balancing in enhancing the system performance. From these studies, we arrive at the following results: (i) load-balancing leads to significant improvement in the end-to-end call acceptance rate, and is an important factor in attaining the maximum end-to-end call acceptance rate in a given network and (ii) it is indeed possible to provide deterministic QoS guarantees for a designated set of nodes which are characterized by “deterministic guarantee limit”.

Keywords Ad hoc wireless networks · QoS routing · TDMA · Call acceptance probability · Load-balancing

1 Introduction

An Ad hoc wireless network is a collection of mobile nodes that can communicate over radio without any pre-existing infrastructure. Two nodes can communicate directly with each other if each lies in the transmission range of the other. Two nodes that cannot directly communicate can do so in a multi-hop manner in which the other nodes function as routers. Such networks are used in military installations and in emergency situations as they permit the establishment of a communication network at very short notice. However, these networks are limited by constraints in their bandwidth and power consumption.

For their widespread deployment, Ad hoc wireless networks now need to support applications that generate real-time traffic such as voice and video. Such traffic requires the network to provide guarantees on the QoS of the connection. The important aspects in the process of providing

S. Sriram
Department of Computer Science, University of California,
Berkeley, CA 94720, USA
e-mail: sriram_s@cs.berkeley.edu

T. Bheemarjuna Reddy (✉)
CalIT2, Jacobs School of Engineering, University of California,
San Diego, CA 92093, USA
e-mail: btamma@ucsd.edu; arjun@cs.iitm.ernet.in

C. Siva Ram Murthy
Department of Computer Science and Engineering,
Indian Institute of Technology Madras, Chennai 600 036, India
e-mail: murthy@iitm.ac.in

such guarantees are the routing protocols that establish paths that can satisfy the QoS requirements and the reservation mechanisms that reserve the necessary resources along the path. A problem of considerable interest in this regard is that of theoretically estimating the nature of the guarantees that can be provided by a QoS scheme. These estimates on the parameters of QoS routing protocols give us an idea of the maximum guarantees that can be provided, and allow us to gauge how far the existing schemes are from the ideal limit.

In this work, we consider the problem of QoS routing for multimedia traffic (i.e., UDP traffic) in a TDMA based Ad hoc wireless network, where the QoS constraint on the calls is that of bandwidth. Our focus is the *end-to-end call acceptance rate* which is a measure of the number of voice or video calls that can be admitted into the network. The calls arriving in the network belong to different classes based on which the requirements of the calls are prioritized. Thus, the parameters that we focus on are: the call acceptance probability and the system saturation probability. The variation of these parameters enables us to answer questions such as (1) What are the maximum number of high-priority calls that can be sustained in the network at a given load?, (2) What is the likelihood that the network enters a state where no more new calls can be accepted?, (3) What is the effect of the routing protocol on the call acceptance?, (4) How close to the theoretical limit do the routing protocols approach? Then, we address the problem of ensuring deterministic call acceptance for a certain sub-set of the calls. We estimate the *deterministic guarantee limit* which is a mobility-independent measure of the number of high-priority calls that can be admitted into the network. We also determine the call acceptance probability for the classes for which deterministic guarantee cannot be provided.

In this work, we model the network at the level of transmission range of each node. The range of a node is analyzed as a Markov process where the calls are the entities to be serviced. The reservation of slots for the call constitutes the service of the call. The modeling of a wireless network as a collection of Markov processes is unique in that, due to the local broadcast nature of the channel, the reservation of slots in the transmission range of a node affects the status of the slots in the neighboring regions. Capturing this property of wireless networks is essential to model the characteristics of the network accurately. Such a modeling must also be able to reflect the characteristics of the routing protocol used. We begin by analyzing a general case of a network that can support multiple-classes of calls where preemption of calls does not exist. We then provide a closed-form estimate of the call acceptance probability and the saturation probability for the case of a single-class of users and discuss the probabilities for the highest-priority class in the preemptive case.

We compare the call acceptance probabilities of shortest-path routing and two routing protocols that attempt load-balancing. Finally, we estimate the deterministic guarantee limit.

The rest of this paper is organized as follows: Sect. 2 briefs the related work in this area, Sect. 3 presents the system model and derives theoretical bounds, Sect. 4 presents load-balancing schemes, Sect. 5 discusses the details of the simulation, and Sect. 6 presents the simulation results. Finally, Sect. 7 concludes the paper with directions for future work.

2 Related work

In their seminal work [1], Gupta and Kumar introduced a random network model for studying throughput scaling in a fixed wireless network. It was shown that even under optimal conditions, the transport capacity (bit-distance product that can be transmitted over the network) of the network is $\theta(\sqrt{n})$ bit-m/s, where n is the number of nodes present in the network, for the protocol model considered.

Further they showed that in such a random network the throughput scales as $\theta\left(\frac{1}{\sqrt{n \log n}}\right)$ per source-destination pair.

In [2], the authors studied scaling laws for the transport capacity as the value of n increases. Further, the optimality of multi-hop operation is provided in some situations. In [3], the authors showed that by allowing nodes to move, the throughput scaling changes dramatically. They showed that if node motion is independent across nodes and has a uniform stationary distribution, a constant throughput scaling ($\theta(1)$) per source-destination pair is feasible. In [4], the authors obtained lower bounds on the capacity of ad hoc networks with two types of non-uniform traffic patterns. In [5], the authors considered power constrained ad hoc networks and demonstrated that throughput capacity increases with node density, in contrast to previously published results. This is the result of the large bandwidth, and the assumed power and rate adaptation, which alleviate interference. In [6, 7], the authors analyzed the performance of IEEE 802.11 DCF based single-hop wireless networks. In [8], the authors proposed a methodology to analytically compute the throughput capacity, or the maximum end-to-end throughput of a given source and destination pair in an IEEE 802.11 DCF based multi-hop wireless network. They considered two key factors which affect the end-to-end throughput capacity: (a) neighboring contentions and (b) hidden node interference.

While previous studies analyze the transport capacity of ad hoc networks, in this work our focus is on the *end-to-end call acceptance rate* which is a measure of the number

of calls with end-to-end bandwidth reservation that can be supported by the network. The previous studies on transport capacity study how it scales with the number of nodes. We study the dependence of end-to-end call acceptance rate on the network load and the routing protocol. The framework that we assume is that of a TDMA based network. The routing scheme employed influences the end-to-end call acceptance rate of the network. In this paper, we investigate the end-to-end call acceptance rate and the influence of shortest-path routing and load-balanced routing protocols on it.

3 Theoretical analysis

We consider an Ad hoc wireless network comprising N nodes uniformly distributed at random in a terrain of area A . The transmission range of each node is R . We assume the presence of a slotted TDMA mechanism at the MAC layer. The channel time is divided into super-frames which in turn are divided into time slots for the transmission and reception of packets by nodes in the network. Time synchronization requires keeping aside some fraction of available time slots in each super-frame to achieve synchronization among nodes in the network. Numerous solutions are proposed in the literature to address time synchronization issue in TDMA based wireless networks [9–11]. One could employ any of those existing solutions to achieve time synchronization. Each super-frame consists of B time slots after excluding those time slots that are kept aside for time synchronization. A node has to reserve one or more slots for communicating with its neighbors. It is also possible to reuse the slots spatially depending on the interference pattern of the nodes. This is the key idea that is used in deriving the bounds.

We define call as a voice or video session consisting of many packets. A call is said to have been set up between two nodes i, j if there is a set of nodes $(p_0 = i, p_1, \dots, p_n = j)$ such that p_{k+1} is in the transmission range of p_k ($p_{k+1} \in \text{region } R(p_k)$) and there is a permissible schedule for transmission of packets from node i at each node p_k ($1 \leq k \leq n - 1$). In the absence of preemption, finding such a schedule is equivalent to finding a set of free slots in each region $R(p_k)$. The definition of a free slot in a region comes later in Sect. 3B.

The bandwidth of a call is measured in terms of the number of slots used for transmission. A call is setup by reserving slots along the path of the call. A node may either transmit or receive in a particular slot (a node is said to receive in a particular slot if any of its neighbors is transmitting in that slot). A slot is said to be free at a node j , ($1 \leq j \leq N$) if it is neither transmitting nor receiving during that slot. For a node j to transmit in a particular slot, the slot must be free at node j and none of the nodes lying in its

transmission range must be receiving in that slot. For a node j to receive in a particular slot, the slot must be free at node j . This definition permits node 6 to transmit to node 5 in the same slot as the one used by node 1 to transmit to node 2 in Fig. 1, provided nodes 1 and 2 do not hear from node 6. On the other hand, in the sender’s range, node 4 must use a different slot to transmit to node 3 because node 3 hears the transmission by node 1.

(A) *System model*: Consider a network $NW = \{1, \dots, N\}$ of N nodes that can support K classes of calls where class i calls have a higher priority than class j ($1 \leq i < j \leq K$) calls. We would like an estimate of how many calls of a particular class can be supported. This implies that we can definitely support such a number of class 1 calls where class 1 is the highest priority class. If all the available slots are occupied by calls of various classes upon arrival of a class j call, one or more calls of lower priority classes can be preempted based on the bandwidth requirement of class j call that has arrived to ensure that the arrived call be accepted. Thus, we would like to provide a guarantee on the number of calls of a particular class that can be accepted.

Assumptions made for the analysis are the following:

- Calls of a particular class- k arrive at each node distributed according to a *Poisson* process of mean λ_k .
- We assume that the calls of all classes have equal bandwidth requirements: each call requires reservation of a single slot in the super-frame. The reserved slot is being used for transmitting one packet of the call in each super-frame till the duration of the call ends (i.e., call departs from the network).
- The duration of a call (voice or video session) is exponentially distributed with mean duration $\frac{1}{\mu_k}$.
- We do not take node mobility into account in the estimation of call acceptance and system saturation.

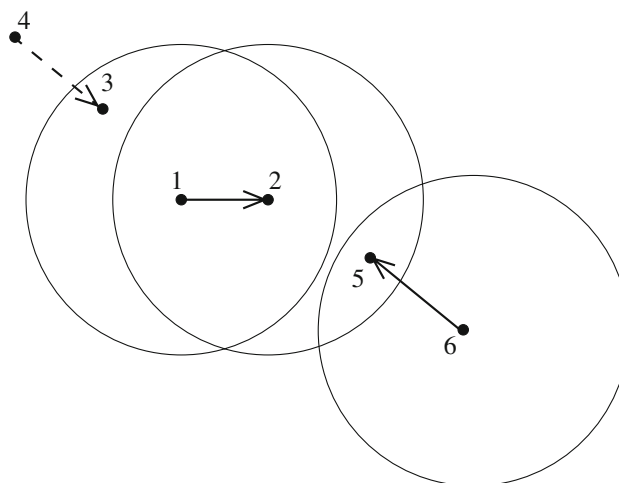

Fig. 1 An example of possible transmissions

(However, the deterministic guarantee limit is independent of mobility.)

- We assume that the routing algorithm is such that for any path found by the algorithm, the number of nodes on the path that lie within the transmission range of any node on the path (inclusive of the node itself) is not greater than some constant c . In the absence of such an assumption, it is possible to construct a scenario (Fig. 2) where a single call needs to use all the slots in the system. In Fig. 2, each of the nodes on the path is in the transmission range of the other nodes. So the use of a slot for transmission by one of the nodes implies that the slot cannot be re-used by the other nodes on the path. Thus, if node A transmits to node B on slot #1, slot #1 cannot be used by any of the other nodes to transmit to their downstream nodes. If we were to consider a P -hop path with the nodes in the configuration given in Fig. 2, the number of slots used would be P . Hence, it would be difficult to provide a bound on the number of calls that can be admitted. This property is satisfied with $c = 3$ for protocols that ensure that if a path is to be set up from A to C , the path used is the link (A, C) rather than links (A, B) and (B, C) , where A, B , and C are nodes such that each can listen to the other two. This can be done by using an appropriate forwarding of the route request packets in which a node drops all except the first route request that it receives.
- We assume that interference range and the transmission range to be the same for all nodes in the network. We denote the interference range by Q and the transmission range by R . When we consider the more general case of Q greater than R , the parameter c will be higher than in the case where $Q = R$. So channel reuse reduces further. Ratio of $\frac{Q}{R}$ dictates the number of slots needed for a multi-hop call. As $\frac{Q}{R}$ increases more number of

slots are needed for multi-hop calls. We study this case in Sect. 3B.7.

(B) *Analytical bounds:* Initially, we assume that call preemption does not occur. We derive upper and lower bounds on the call acceptance probability for the case of single-hop and multi-hop calls respectively. Consider a node j and the region spanned by its transmission range $R(j)$. Any call passing through $R(j)$ uses up some number of slots. The number of slots used up in the region $R(j)$ depends on the number of calls originated from node j , the number of calls from any of the neighbors of node j , the number of calls that originate from outside $R(j)$ and are terminated at some node in $R(j)$, and the number of calls that originate from outside $R(j)$ and are routed through $R(j)$. A slot is said to be *free* in $R(j)$ if no nodes in $R(j)$ are either transmitting or receiving in that slot (i.e., slot is free at all nodes in region $R(j)$). In Fig. 3, node A transmits to node B on slot 1. Node D transmits to node B on slot 2. Node E transmits to node C on slot 3. If the network had a total of 5 slots, the free slots at node A would be $\{2,3,4,5\}$ while the free slots in the region $R(A)$ would be $\{4,5\}$.

We can thus view $R(j)$ as a server of slots for which the calls contend. Although the distribution of call arrivals of a particular class at each node is known to be Poisson, the distribution of calls arriving at $R(j)$ is not Poisson due to the splitting of the Poisson streams (Consider calls arriving at a node based on a Poisson process of mean λ . Assume that the node has to forward the call along one of two links. If the node forwards calls in a non-random manner, the arrival of calls at the downstream node will no longer be Poisson). We make use of Kleinrock's Independence Assumption, according to which, for moderately heavy call arrival at each node, the net call arrival at the region $R(j)$

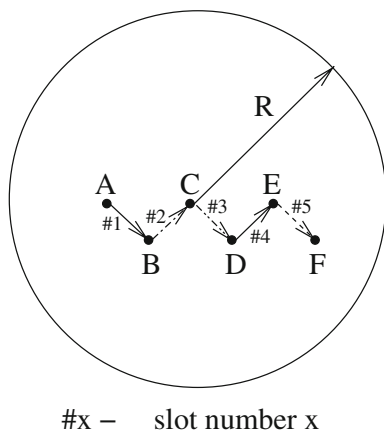

Fig. 2 An example scenario

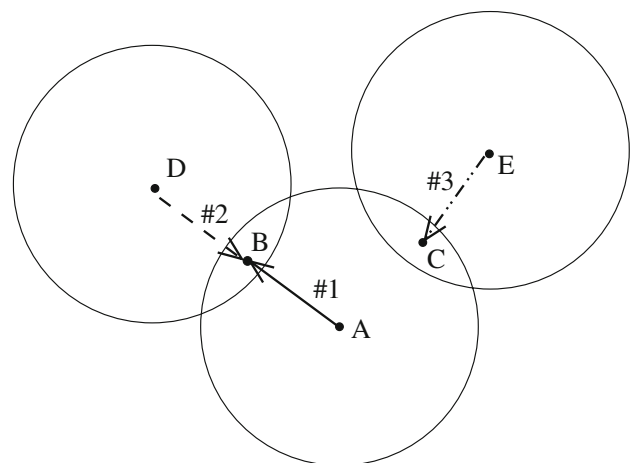

Fig. 3 An example to distinguish free slots at a node and free slots in a region

can be regarded as Poisson. Thus, calls of a class- k arrive at $R(j)$ according to a Poisson distribution with mean:

$$\lambda_k(j) = \sum_{i=1}^{i=N} f_k(i, j) \lambda_k$$

where $f_k(i, j)$ is the fraction of class- k calls originating in node i that pass through the region $R(j)$. This can be rewritten as:

$$\lambda_k(j) = \left(\sum_{i \notin R(j)} f_k(i, j) + |N(j)| + 1 \right) \lambda_k \tag{1}$$

where $N(j)$ denotes the set of nodes in the transmission range of node j . The parameter $f_k(i, j)$ is dependent on the routing protocol. For a protocol such as shortest-path routing, which leads to heavy loads in the center of the network, $f_k(i, j)$ would be high for nodes j ($1 \leq j \leq N$) located near the center. For protocols that implement load-balancing, the value of $f_k(i, j)$ should be fairly uniform across the nodes.

The state of the system $R(j)$ is given by the number of calls of each class being served (each of which uses up some of the slots of $R(j)$) by $R(j)$. We thus model $R(j)$ as a K -dimensional discrete-time Markov process¹ $X(t) = (n_1, \dots, n_K)$, where n_k denotes the number of class- k calls being served by $R(j)$ at time t [14]. The use of a Markov process is appropriate here because for these wireless networks, the slot allocations at any instant of time only depend on the allocated slots at the previous instant and the arrivals and departures of calls in that instant. A process that has greater dependence on the past may be appropriate in modeling systems which attempt to achieve long-term fairness of slot allocation, for example. However, for the setting considered in the paper, a first-order Markov process is a natural model.

We denote: $P((n_1', \dots, n_K') | (n_1, \dots, n_K)) = P(X(t + \Delta t) = (n_1', \dots, n_K') | X(t) = (n_1, \dots, n_K))$ as the probability that the system $R(j)$ is in the state (n_1', \dots, n_K') at time $t + \Delta t$ given it is in the state (n_1, \dots, n_K) at time t .

$$P((n_1, \dots, n_k + 1, \dots, n_K) | (n_1, \dots, n_k, \dots, n_K)) = \lambda_k(j) \Delta t \tag{2}$$

$$P((n_1, \dots, n_k - 1, \dots, n_K) | (n_1, \dots, n_k, \dots, n_K)) = n_k \mu_k \Delta t, \quad n_k > 0 \tag{3}$$

We have used a discrete-time Markov chain in our setting. The approximation used in this setting however is

¹ In the most general case of a model corresponding to K classes of calls in a network having B slots, the Markov process has $\binom{K+B}{B}$ states. This is not a problem for the current analysis since the transitions between the states are restricted: every state has at most $2K$ neighboring states, and the processes associated with any given regions are decoupled. Further, we are interested in only the steady state of the process and not in the paths traversed. The state-explosion needs to be tackled for an analysis that considers coupled processes or preemptive calls: the interested reader may refer [12] and [13].

that the probability of more than one call arriving or departing within a super-frame is low. This is a valid approximation when the super-frame lengths are small (as is the case for the case for wireless networks with high bandwidth). In this scenario, the system has transition probabilities that are similar to those for a continuous-time Markov chain for a small interval. In effect, the system has transition probabilities that are identical to those described in above equations. The state-transition diagram representing the transitions into and out of one of the states of the Markov process is shown in Fig. 4.²

The Markov process has a unique steady-state probability distribution [14]. Using Eqs. 2 and 3 along with the normalization of probabilities, we can calculate the probability that the system is in a particular state (n_1, \dots, n_K) as:

$$P((n_1, \dots, n_K)) = \frac{1}{G(j)} \prod_{k=1}^{k=K} \frac{\rho_k(j)^{n_k}}{n_k!} \tag{4}$$

where $\rho_k(j) = \frac{\lambda_k(j)}{\mu_k}$ and $G(j) = \sum_{0 \leq n_1 + \dots + n_K \leq B} \prod_{k=1}^{k=K} \frac{\rho_k(j)^{n_k}}{n_k!}$ is a normalization factor.

We would now like to extend this Markov process to distinguish between calls that terminate in a node in $R(j)$ (call them type-U calls) and those that do not (type-V calls). Let us say that a fraction f of the calls terminate in some node in $R(j)$. If the destination were to be chosen randomly, then $f = \frac{|N(j)|+1}{N}$. The state of the system is now given by:

$$(n_{1,U}, n_{1,V}, n_{2,U}, n_{2,V}, \dots, n_{K,U}, n_{K,V})$$

where $n_{k,U}$ is the number of class- k calls that are type-U calls in $R(j)$ and $n_{k,V}$ is the number of class- k calls that are type-V calls.

The probability that the system is in a state $(n_{1,U}, n_{1,V}, \dots, n_{K,U}, n_{K,V})$ is:

$$P((n_{1,U}, n_{1,V}, \dots, n_{K,U}, n_{K,V})) = \frac{1}{E(j)} \prod_{k=1}^{k=K} \frac{\rho_{k,U}(j)^{n_{k,U}}}{n_{k,U}!} \frac{\rho_{k,V}(j)^{n_{k,V}}}{n_{k,V}!}$$

where $\rho_{k,U}(j) = \frac{f \lambda_k(j)}{\mu_k}$, $\rho_{k,V}(j) = \frac{(1-f) \lambda_k(j)}{\mu_k}$, and $E(j) = \sum_{n_{1,U}, n_{1,V}, \dots, n_{K,U}, n_{K,V}} \prod_{k=1}^{k=K} \frac{\rho_{k,U}(j)^{n_{k,U}}}{n_{k,U}!} \frac{\rho_{k,V}(j)^{n_{k,V}}}{n_{k,V}!}$ is a normalization factor.

The probability that the system is in a state $(n_{1,V}, n_{2,V}, \dots, n_{K,V})$ (a state in which there are $n_{1,V}$ class-1 type-V calls, $n_{2,V}$ class-2 type-V calls, and so on) is:

$$P((n_{1,V}, \dots, n_{K,V})) = \frac{1}{H(j)} \prod_{k=1}^{k=K} \frac{\rho_{k,V}(j)^{n_{k,V}}}{n_{k,V}!} \tag{5}$$

² For the case of preemption, the system can move between certain other states. Corresponding to the case of preemption of a class-2 call by a class-1 call, the system can move from the state (n_1, n_2, \dots, n_K) to $(n_1 + 1, n_2 - 1, \dots, n_K)$, $n_2 \geq 1$.

Fig. 4 The transitions into and out of one of the states of the Markov process representing the region $R(j)$. For the state (n_1, n_2, \dots, n_K) , $n_1 > 0, n_2 > 0, \dots, n_K > 0$

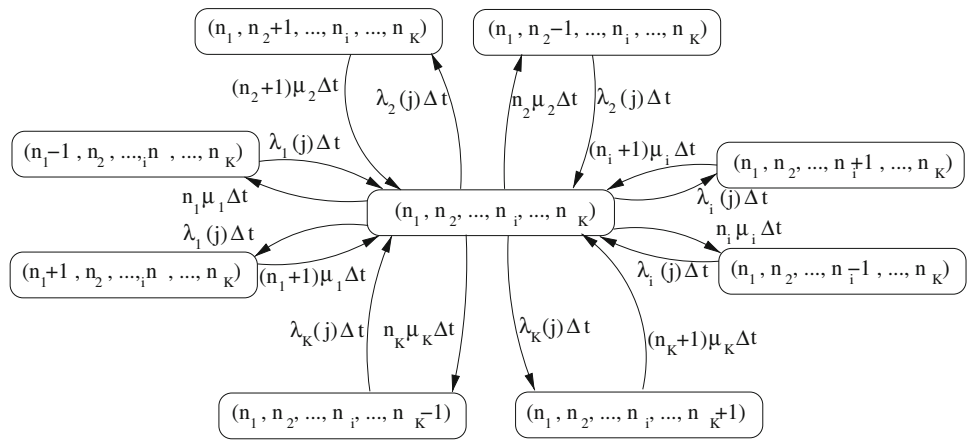

where $H(j) = \sum_{0 \leq n_{1,V} + \dots + n_{K,V} \leq B} \prod_{k=1}^{k=K} \frac{\rho_{k,V}(j)^{n_{k,V}}}{n_{k,V}!}$ is a normalization factor.

(1) *Call acceptance probability:* In this section, we are going to derive the call acceptance probability of both single-hop and multi-hop cases for a non-preemptive system (a system where the accepted calls are not dropped for a new call).

Lemma 1 $P(\text{Number of used slots in a region } R(j) \leq x) \leq P(\text{Number of type-V calls in } R(j) \leq x)$, where $x \in \mathbb{N}$.

Proof For every type-V call, at least one unique (till then unused) free slot in the region $R(j)$ must be used (see Fig. 5). Thus:

$$\begin{aligned} \text{Number of type-V calls in } R(j) > x &\Rightarrow \text{Number of used slots in } R(j) > x \\ \text{and} & \\ \text{Number of used slots in } R(j) \leq x &\Rightarrow \text{Number of type-V calls in } R(j) \leq x \\ \text{Hence } P(\text{Number of used slots in } R(j) \leq x) &\leq P(\text{Number of type-V calls in } R(j) \leq x) \quad \square \end{aligned}$$

Lemma 2 $P(\text{Number of calls in a region } R(j) \leq x) \leq P(\text{Number of used slots in a region } R(j) \leq cx)$, where $x \in \mathbb{N}$ and c is the routing-algorithm dependent constant factor that denotes the maximum number of nodes on a path that lie within the transmission range of any node on the path.

Proof

$$\begin{aligned} \text{Number of calls in } R(j) \leq x &\Rightarrow \text{Number of used slots in } R(j) \leq cx \\ \text{Hence } P(\text{Number of calls in } R(j) \leq x) &\leq P(\text{Number of used slots in } R(j) \leq cx) \quad \square \end{aligned}$$

Theoretical upper bound for probability of call acceptance: We now derive an upper bound on the probability of call acceptance for the cases of single-hop and multi-hop calls.

Single-hop case: Consider a single-hop call from node j to its neighbor node l . For the call to be accepted, at least one slot must be free in the region $R(j)$. Thus P_{Acc} (probability of a single-hop call is accepted) is:

$$\begin{aligned} P_{Acc} &= P(\text{Number of free slots} \geq 1) \\ &= P(\text{Number of used slots} \leq B - 1) \end{aligned}$$

where B is the total number of slots in the system. From Lemma 1:

$$\begin{aligned} P_{Acc} &\leq P(\text{Number of type-V calls} \leq B - 1) \\ &\leq 1 - P(\text{Number of type-V calls} > B - 1) \\ &\leq 1 - P(\text{Number of type-V calls} = B) \quad (6) \\ P_{Acc} &\leq 1 - \sum_{n_{1,V} + n_{2,V} + \dots + n_{K,V} = B} \frac{1}{H(j)} \prod_{k=1}^{k=K} \frac{\rho_{k,V}(j)^{n_{k,V}}}{n_{k,V}!} \end{aligned}$$

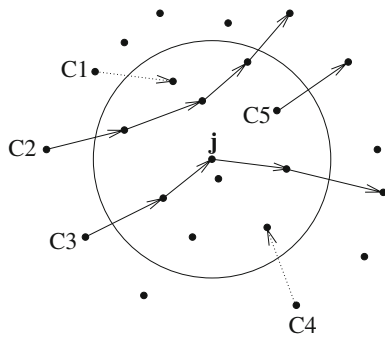

Fig. 5 In the region $R(j)$, C1 and C4 are type-U calls; C2, C3, and C5 are type-V calls. For each type-V call, we see that at least one slot that has not been used so far in $R(j)$ must be used. For the type-U calls, slot reuse is possible in some cases

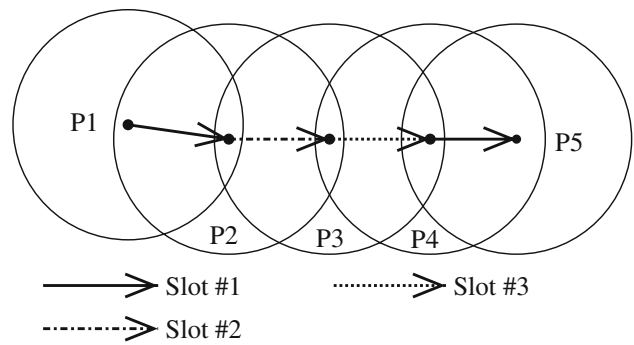

Fig. 6 Multi-hop call setup. $R(P_1)$ needs slot #1 to be free. $R(P_2)$ now cannot use slot #1 and requires slot #2 (some other slot) to be free. $R(P_3)$ cannot use slots #1 and #2, and requires slot #3 (any other slot) to be free. $R(P_4)$ can transmit in slot #1 if it is free

For the case of a single-class of calls, Eq. 6 reduces to

$$P_{Acc} \leq 1 - \frac{1}{H(j)} \frac{\rho_{1,V}(j)^B}{B!} \tag{7}$$

Multi-hop case: We set the constant $c = 3$. Consider a $(M - 1)$ -hop call ($M \geq 3$) setup along the nodes (p_1, \dots, p_M) . When a slot is reserved for transmission between p_1 and p_2 , the total number of free slots at $R(p_2)$ decreases by 1 (since the slot cannot be used for transmission from p_2 to p_3). Thus, the total number of slots available at $R(p_2)$ can be considered

A call is *successfully forwarded* in region $R(j)$ if slots can be found in $R(j)$ so that the call having arrived at node j is forwarded to its next hop in the path. For the call to be accepted, it must first be successfully forwarded in the region $R(p_1)$, must then be successfully forwarded through each of the regions $R'(p_2), R''(p_3), \dots, R''(p_{M-1})$. A necessary and sufficient condition for successful forwarding is the presence of at least one free slot in each of the intermediate regions.

Thus P_{Acc} is given by:

$$P_{Acc} = P(\text{Successful forwarding of call in } R(p_1)) \times P(\text{Successful forwarding of call in } R'(p_2) | \text{Successful forwarding of call in } R(p_1)) \times P(\text{Successful forwarding of call in } R''(p_3) | \text{Successful forwarding of call in } R'(p_2)) \times \dots \times P(\text{Successful forwarding of call in } R''(p_{M-1}) | \text{Successful forwarding of call in } R''(p_{M-2}))$$

$$P_{Acc} = P(\text{No. of free slots in } R(p_1) \geq 1) \times P(\text{No. of free slots in } R'(p_2) \geq 1 | \text{Successful forwarding of call in } R(p_1)) \times P(\text{No. of free slots in } R''(p_3) \geq 1 | \text{Successful forwarding of call in } R'(p_2)) \times \dots \times P(\text{No. of free slots in } R''(p_{M-1}) \geq 1 | \text{Successful forwarding of call in } R''(p_{M-2})) \tag{8}$$

as $B - 1$. Call this modified region $R'(p_2)$. When slots have been reserved between p_1 and p_2 , and between p_2 and p_3 , the number of free slots at $R(p_3)$ decreases by 2 so that the total number of slots at $R(p_3)$ can be regarded as $B - 2$. Call this modified region $R''(p_3)$. The number of slots, for the regions $R(p_3), \dots, R(p_{M-1})$, is thus effectively, $B - 2$ (since $c = 3$). (Thus, according to this notation, a region $R'(j)$ has one fewer slot, while $R''(j)$ has two fewer slots). A multi-hop call setup for $M = 5$ is shown in Fig. 6.

From Lemma 1:

$$P_{Acc} \leq P(\text{No. of type-V calls in } R(p_1) \leq B - 1) \times P(\text{No. of type-V calls in } R'(p_2) \leq B - 2) \times P(\text{No. of type-V calls in } R''(p_3) \leq B - 3) \times \dots \times P(\text{No. of type-V calls in } R''(p_{M-1}) \leq B - 3)$$

$$\begin{aligned}
 P_{Acc} &\leq \left(1 - \sum_{n_{1,V}+n_{2,V}+\dots+n_{K,V}=B} \frac{1}{H(p_1)} \prod_{k=1}^{k=K} \frac{\rho_{k,V}(p_1)^{n_{k,V}}}{n_{k,V}!}\right) \\
 &\times \left(1 - \sum_{n_{1,V}+n_{2,V}+\dots+n_{K,V}=B-1} \frac{1}{H'(p_2)} \prod_{k=1}^{k=K} \frac{\rho_{k,V}(p_2)^{n_{k,V}}}{n_{k,V}!}\right) \\
 &\times \left(1 - \sum_{n_{1,V}+n_{2,V}+\dots+n_{K,V}=B-2} \frac{1}{H''(p_3)} \prod_{k=1}^{k=K} \frac{\rho_{k,V}(p_3)^{n_{k,V}}}{n_{k,V}!}\right) \\
 &\times \dots \left(1 - \sum_{n_{1,V}+n_{2,V}+\dots+n_{K,V}=B-2} \frac{1}{H''(p_{M-2})} \prod_{k=1}^{k=K} \frac{\rho_{k,V}(p_{M-2})^{n_{k,V}}}{n_{k,V}!}\right) \\
 &\times \left(1 - \sum_{n_{1,V}+n_{2,V}+\dots+n_{K,V}=B-2} \frac{1}{H''(p_{M-1})} \prod_{k=1}^{k=K} \frac{\rho_{k,V}(p_{M-1})^{n_{k,V}}}{n_{k,V}!}\right)
 \end{aligned} \tag{9}$$

where $H'(j) = \sum_{0 \leq n_{1,V}+\dots+n_{K,V} \leq B-1} \prod_{k=1}^{k=K} \frac{\rho_{k,V}(j)^{n_{k,V}}}{n_{k,V}!}$ and $H''(j) = \sum_{0 \leq n_{1,V}+\dots+n_{K,V} \leq B-2} \prod_{k=1}^{k=K} \frac{\rho_{k,V}(j)^{n_{k,V}}}{n_{k,V}!}$. For the case of a single-class of calls, Eq. 9 reduces to

$$\begin{aligned}
 P_{Acc} &\leq \left[1 - \frac{1}{H(p_1)} \frac{\rho_{1,V}(p_1)^B}{B!}\right] \\
 &\times \left[1 - \frac{1}{H'(p_2)} \frac{\rho_{1,V}(p_2)^{B-1}}{(B-1)!}\right] \\
 &\times \left[1 - \frac{1}{H''(p_3)} \frac{\rho_{1,V}(p_3)^{B-2}}{(B-2)!}\right] \\
 &\times \dots \left[1 - \frac{1}{H''(p_{M-2})} \frac{\rho_{1,V}(p_{M-2})^{B-2}}{(B-2)!}\right] \\
 &\times \left[1 - \frac{1}{H''(p_{M-1})} \frac{\rho_{1,V}(p_{M-1})^{B-2}}{(B-2)!}\right]
 \end{aligned} \tag{10}$$

The RHS (Right Hand Side) of Eqs. 7 and 10 are hard to solve for in a closed-form. For moderate-to-heavy traffic, $\rho > 1$ and the inequality remains valid if we replace $\rho_{1,V}(p_j)$, $1 \leq j \leq M - 1$ by $\rho_{1,V}^{Max}$ (the maximum value of $\rho_{1,V}(p_j)$ across all the regions). Denoting the RHS as P_{Acc}^{Max} :

$$P_{Acc}^{Max} = 1 - \frac{1}{H} \frac{\rho_{1,V}^{MaxB}}{B!} \text{ for single-hop calls} \tag{11}$$

$$\begin{aligned}
 P_{Acc}^{Max} &= \left[1 - \frac{1}{H} \frac{\rho_{1,V}^{MaxB}}{B!}\right] \times \left[1 - \frac{1}{H'} \frac{\rho_{1,V}^{MaxB-1}}{(B-1)!}\right] \\
 &\times \left[1 - \frac{1}{H''} \frac{\rho_{1,V}^{MaxB-2}}{(B-2)!}\right]^{M-3} \text{ for multi-hop calls}
 \end{aligned} \tag{12}$$

where $H = \sum_{b=0}^{b=B} \frac{\rho_{1,V}^{Maxb}}{b!}$, $H' = \sum_{b=0}^{b=B-1} \frac{\rho_{1,V}^{Maxb}}{b!}$, and $H'' = \sum_{b=0}^{b=B-2} \frac{\rho_{1,V}^{Maxb}}{b!}$.

Theoretical lower bound for probability of call acceptance: In this section, we derive lower bounds on the

probability of call acceptance for the case of single-hop and multi-hop calls.

Single-hop case: For the single-hop case, a call from node j to its neighbor node l is accepted if there is at least one free slot in the region $R(j)$. From our assumption about the fact that the routing protocol satisfies the property that at most c nodes on the path can hear any other node on the path, we have for a given number of calls in the region $R(j)$

$$\begin{aligned}
 P_{Acc} &= P(\text{Number of free slots} \geq 1) \\
 &= P(\text{Number of used slots} \leq B - 1)
 \end{aligned}$$

Using Lemma 2

$$\begin{aligned}
 P_{Acc} &\geq P\left(\text{Number of calls} \leq \left\lfloor \frac{B-1}{c} \right\rfloor\right) \\
 &\geq \frac{1}{G(j)} \sum_{n_1+n_2+\dots+n_K \leq \lfloor \frac{B-1}{c} \rfloor} \prod_{k=1}^{k=K} \frac{\rho_k(j)^{n_k}}{n_k!}
 \end{aligned} \tag{13}$$

where $G(j) = \sum_{0 \leq n_1+\dots+n_K \leq B} \prod_{k=1}^{k=K} \frac{\rho_k(j)^{n_k}}{n_k!}$. For a single-class of calls

$$P_{Acc} \geq \frac{1}{G(j)} \sum_{i=0}^{i=\lfloor \frac{B-1}{c} \rfloor} \frac{\rho_1(j)^i}{i!}, \text{ where } G(j) = \sum_{i=0}^{i=B} \frac{\rho_1(j)^i}{i!}. \tag{14}$$

Multi-hop case: Consider the attempt to setup an $(M - 1)$ -hop call ($M \geq 3$) along the nodes (p_1, \dots, p_M) . The probability of call acceptance is given by Eq. 8. From Eq. 8 and Lemma 2:

$$\begin{aligned}
 P_{Acc} &\geq P\left(\text{Number of calls in } R(p_1) \leq \left\lfloor \frac{B-1}{c} \right\rfloor\right) \\
 &\times P\left(\text{Number of calls in } R'(p_2) \leq \left\lfloor \frac{B-2}{c} \right\rfloor\right) \\
 &\times P\left(\text{Number of calls in } R''(p_3) \leq \left\lfloor \frac{B-3}{c} \right\rfloor\right) \\
 &\times \dots P\left(\text{Number of calls in } R''(p_{M-1}) \leq \left\lfloor \frac{B-3}{c} \right\rfloor\right)
 \end{aligned}$$

$$\begin{aligned}
 P_{Acc} &\geq \frac{1}{G(p_1)} \sum_{n_1+n_2+\dots+n_K \leq \lfloor \frac{B-1}{c} \rfloor} \prod_{k=1}^{k=K} \frac{\rho_k(p_1)^{n_k}}{n_k!} \\
 &\times \frac{1}{G'(p_2)} \sum_{n_1+n_2+\dots+n_K \leq \lfloor \frac{B-2}{c} \rfloor} \prod_{k=1}^{k=K} \frac{\rho_k(p_2)^{n_k}}{n_k!} \\
 &\times \dots \frac{1}{G''(p_{M-2})} \sum_{n_1+n_2+\dots+n_K \leq \lfloor \frac{B-3}{c} \rfloor} \prod_{k=1}^{k=K} \frac{\rho_k(p_{M-2})^{n_k}}{n_k!} \\
 &\times \frac{1}{G''(p_{M-1})} \sum_{n_1+n_2+\dots+n_K \leq \lfloor \frac{B-3}{c} \rfloor} \prod_{k=1}^{k=K} \frac{\rho_k(p_{M-1})^{n_k}}{n_k!}
 \end{aligned} \tag{15}$$

where $G'(j) = \sum_{0 \leq n_1 + \dots + n_K \leq B-1} \prod_{k=1}^{k=K} \frac{\rho_k(j)^{n_k}}{n_k!}$ and $G''(j) = \sum_{0 \leq n_1 + \dots + n_K \leq B-2} \prod_{k=1}^{k=K} \frac{\rho_k(j)^{n_k}}{n_k!}$.

For the single-class case:

$$\begin{aligned}
 P_{Acc} &\geq \frac{1}{G(p_1)} \sum_{i=0}^{i=\lfloor \frac{B-1}{c} \rfloor} \frac{\rho_1(p_1)^i}{i!} \\
 &\times \frac{1}{G'(p_2)} \sum_{i=0}^{i=\lfloor \frac{B-2}{c} \rfloor} \frac{\rho_1(p_2)^i}{i!} \\
 &\times \dots \\
 &\frac{1}{G''(p_{M-2})} \sum_{i=0}^{i=\lfloor \frac{B-3}{c} \rfloor} \frac{\rho_1(p_{M-2})^i}{i!} \\
 &\times \frac{1}{G''(p_{M-1})} \sum_{i=0}^{i=\lfloor \frac{B-3}{c} \rfloor} \frac{\rho_1(p_{M-1})^i}{i!} \tag{16}
 \end{aligned}$$

Using the same approximations as in Eqs. 11 and 12, we can determine the minimum value of the acceptance probability P_{Acc}^{Min} .

$$P_{Acc}^{Min} = \frac{1}{G} \sum_{i=0}^{i=\lfloor \frac{B-1}{c} \rfloor} \frac{\rho^{Min^i}}{i!} \text{ for single-hop calls} \tag{17}$$

$$\begin{aligned}
 P_{Acc}^{Min} &= \left[\frac{1}{G} \sum_{i=0}^{i=\lfloor \frac{B-1}{c} \rfloor} \frac{\rho^{Min^i}}{i!} \right] \times \left[\frac{1}{G'} \sum_{i=0}^{i=\lfloor \frac{B-2}{c} \rfloor} \frac{\rho^{Min^i}}{i!} \right] \\
 &\times \left[\frac{1}{G''} \sum_{i=0}^{i=\lfloor \frac{B-3}{c} \rfloor} \frac{\rho^{Min^i}}{i!} \right]^{M-3} \text{ for multi-hop calls} \tag{18}
 \end{aligned}$$

where $G = \sum_{i=0}^{i=B} \frac{\rho^{Max^i}}{i!}$, $G' = \sum_{i=0}^{i=B-1} \frac{\rho^{Max^i}}{i!}$, and $G'' = \sum_{i=0}^{i=B-2} \frac{\rho^{Max^i}}{i!}$.

(2) *The Case of Preemption:* The analysis so far has been done under the assumption that high-priority calls cannot preempt lower-priority ones. However, a realistic scenario may require that high-priority calls are ensured high probability of call acceptance. This may require introduction of preemption into the system. The analysis of the steady-state probabilities of a preemptive Markov process is a difficult problem. The stationary distribution of the highest priority calls can be easily obtained since these calls effectively ignore the presence of other low-priority calls. Thus, the stationary distribution of the class-1 calls is the same as that of the single-class system given in Eqs. 11, 12, 17, and 18.

(3) *System Saturation Probability:* For the case of a single-class of calls, the probability that the network is

saturated i.e., no further calls can be accepted is given by P_{Sat} . If the number of type-V calls in a region is B , then this would require at least B slots to be used, and no further calls can be accepted.

$$P(\text{Saturation in } R(j)) = P(B \text{ slots are used})$$

$$\begin{aligned}
 P(\text{Saturation in } R(j)) &\geq P(\text{Number of type-V calls at } R(j) = B) \\
 &\geq \frac{1}{H(j)} \frac{\rho_{1,V}(j)^B}{B!} \tag{19}
 \end{aligned}$$

$$P_{Sat} \geq \prod_{i=1}^{i=N} \frac{1}{H(i)} \frac{\rho_{1,V}(i)^B}{B!} \tag{20}$$

$$P_{Sat} \geq \left[\frac{1}{H} \frac{\rho_{1,V}^{Max^B}}{B!} \right]^N \tag{21}$$

(4) *Calls with Varying Bandwidth:* We now consider the case where the calls have varying bandwidth requirements i.e., in other words, each call uses up different numbers of slots. The class of the call is determined by its bandwidth requirement. So we now have K classes of calls. Class 1 calls require 1 slot, class 2 calls require 2 slots, class k calls require k slots, and so on. We assume that the calls of all classes have equal priority, i.e., no call preemption in the network. The varying number of slots changes the results presented in Lemmas 1 and 2. If we were to consider the type-V calls in a region $R(j)$, a type-V call of class i , $1 \leq i \leq K$ would consume at least i slots. Hence, Lemma 1 is replaced by

Lemma 3 $P(\text{Number of used slots in a region } R(j) \leq x) \leq P(\sum_{i=1}^K i \cdot n_{i,V} \leq x)$, where $x \in \mathbb{N}$.

Similarly, Lemma 2 is replaced by

Lemma 4 $P(\sum_{i=1}^K i \cdot n_i \leq x) \leq P(\text{Number of used slots in a region } R(j) \leq cx)$, where $x \in \mathbb{N}$.

Plugging these inequalities into the derivation for bounds for the single and the multiple hop cases, we get the following bounds for the call acceptance probability for a class b call which requires b slots:

$$\begin{aligned}
 P_{Acc}^{Max}(b) &= 1 - \sum_{B-b+1 \leq \sum_{i=1}^K i \cdot n_{i,V} \leq B} \\
 &\frac{1}{H(b)} \prod_{k=1}^{k=K} \frac{\rho_{k,V}^{Max^{n_{k,V}}}}{n_{k,V}!} \text{ for single-hop calls} \tag{22}
 \end{aligned}$$

$$P_{Acc}^{Max}(b) = \left[1 - \sum_{B-b+1 \leq \sum_{i=1}^K i \cdot n_{i,V} \leq B} \frac{1}{H(b)} \prod_{k=1}^{k=K} \frac{\rho_{k,V}^{Max^{n_{k,V}}}}{n_{k,V}!} \right] \times \left[1 - \sum_{B-2b+1 \leq \sum_{i=1}^K i \cdot n_{i,V} \leq B-b} \frac{1}{H'(b)} \prod_{k=1}^{k=K} \frac{\rho_{k,V}^{Max^{n_{k,V}}}}{n_{k,V}!} \right] \times \left[1 - \sum_{B-3b+1 \leq \sum_{i=1}^K i \cdot n_{i,V} \leq B-2b} \frac{1}{H''(b)} \prod_{k=1}^{k=K} \frac{\rho_{k,V}^{Max^{n_{k,V}}}}{n_{k,V}!} \right]^{M-3}$$

for multi-hop calls (23)

where $H(b) = \sum_{0 \leq \sum_{i=1}^K i \cdot n_{i,V} \leq B} \prod_{k=1}^{k=K} \frac{\rho_{k,V}^{Max^{n_{k,V}}}}{n_{k,V}!}$, $H'(b) = \sum_{0 \leq \sum_{i=1}^K i \cdot n_{i,V} \leq B-b} \prod_{k=1}^{k=K} \frac{\rho_{k,V}^{Max^{n_{k,V}}}}{n_{k,V}!}$, and $H''(b) = \sum_{0 \leq \sum_{i=1}^K i \cdot n_{i,V} \leq B-2b} \prod_{k=1}^{k=K} \frac{\rho_{k,V}^{Max^{n_{k,V}}}}{n_{k,V}!}$

$$P_{Acc}^{Min}(b) = \frac{1}{G(b)} \sum_{0 \leq \sum_{i=1}^K i \cdot n_i \leq \lfloor \frac{B-c}{c} \rfloor} \prod_{k=1}^{k=K} \frac{\rho_k^{Min^{n_k}}}{n_k!}$$

for single-hop calls (24)

$$P_{Acc}^{Min}(b) = \left[\frac{1}{G(b)} \sum_{0 \leq \sum_{i=1}^K i \cdot n_i \leq \lfloor \frac{B-c}{c} \rfloor} \prod_{k=1}^{k=K} \frac{\rho_k^{Min^{n_k}}}{n_k!} \right] \times \left[\frac{1}{G'(b)} \sum_{0 \leq \sum_{i=1}^K i \cdot n_i \leq \lfloor \frac{B-2b}{c} \rfloor} \prod_{k=1}^{k=K} \frac{\rho_k^{Min^{n_k}}}{n_k!} \right] \times \left[\frac{1}{G''(b)} \sum_{0 \leq \sum_{i=1}^K i \cdot n_i \leq \lfloor \frac{B-3b}{c} \rfloor} \prod_{k=1}^{k=K} \frac{\rho_k^{Min^{n_k}}}{n_k!} \right]^{M-3}$$

for multi-hop calls (25)

where $G(b) = \sum_{0 \leq \sum_{i=1}^K i \cdot n_i \leq B} \prod_{k=1}^{k=K} \frac{\rho_k^{Max^{n_k}}}{n_k!}$, $G'(b) = \sum_{0 \leq \sum_{i=1}^K i \cdot n_i \leq B-b} \prod_{k=1}^{k=K} \frac{\rho_k^{Max^{n_k}}}{n_k!}$, and $G''(b) = \sum_{0 \leq \sum_{i=1}^K i \cdot n_i \leq B-2b} \prod_{k=1}^{k=K} \frac{\rho_k^{Max^{n_k}}}{n_k!}$.

Note that these bounds tell us that it is not possible for a call requiring more than $\frac{B}{3}$ to be setup on a path of length greater than 2, which is intuitively obvious.

(5) *Some examples: Example 1* Consider a scenario where all nodes are within each others' transmission range. Also, there is just a single slot in the TDMA system i.e., $B = 1$ so that only one class 1 call can be active in the

system. Also all calls belong to the class 1 and hence have the same bandwidth requirements. The entire network is now a Markov process with two states: state 1 in which there is a call that has been accepted into the system and state 0 in which there is no call active in the network. The system moves from state 0 to 1 when a call arrives at any of the nodes—this process is Poisson distributed with mean $N\lambda$. We can compute the probability that system is in each state. Consequently, the probability that a new call is accepted is $P_{Acc} = P(state\ 0) = \frac{1}{1+\rho}$, $\rho = \frac{N\lambda}{\mu}$. For a single-hop call, from Eqs. 11 and 17, we get $P_{Acc}^{Max} = P_{Acc}^{Min} = \frac{1}{1+\rho}$.

Example 2 Consider another scenario where there are three nodes A, B, and C so that A and C are neighbors of B but A and C are not neighbors. There are 2 slots in the TDMA system. The system behavior can be modeled as a Markov process with states representing all possible configurations of class 1 calls in the system. In this case, there are 4 states corresponding to 0 calls, 1 call that occupies a single slot (a call from A or C to B), a single call that occupies 2 slots (a call from A to C), and 2 calls. The resulting transition matrix and steady state probabilities are shown in Table 1.

The probability of acceptance of a single-hop call $P_{Acc} = P(0) + P(1) = \frac{1}{1+\rho}$. The corresponding bounds from Eqs. 11 and 17 reduce to $P_{Acc}^{Min} = \frac{1}{1+\rho+\frac{1}{2}\rho^2}$ and $P_{Acc}^{Max} = \frac{\rho(1+\rho)}{1+\rho+\frac{1}{2}\rho^2}$. It is easy to verify that $P_{Acc}^{Min} \leq P_{Acc} \leq P_{Acc}^{Max}$. Define $\Delta(\rho) = \max(\frac{P_{Acc}-P_{Acc}^{Min}}{P_{Acc}}, \frac{P_{Acc}^{Max}-P_{Acc}}{P_{Acc}})$. We can show that $\Delta(\rho) = O(1)$ for $\rho \rightarrow \infty$ and $\Delta(\rho) = o(1)$ for $\rho \rightarrow 0$.

The probability of acceptance of a two-hop call $P_{Acc} = P(0) = \frac{1}{(1+2\rho)(1+\rho)}$. The bounds are now $P_{Acc}^{Max} = \frac{1}{1+\rho+\frac{1}{2}\rho^2}$ and $P_{Acc}^{Min} = \frac{1}{(1+\rho+\frac{1}{2}\rho^2)^2}$. Again $\Delta(\rho) = O(1)$ for $\rho \rightarrow \infty$ and $\Delta(\rho) = o(1)$ for $\rho \rightarrow 0$.

(6) *A Summary of the Results:*

- The Eqs. 11, 12, 17, and 18 suggest that the call acceptance decreases with system load, this decrease being rapid at high loads.
- For an incoming call's chances of acceptance to be maximized, Eqs. 6 and 9 suggest that the minimum $\rho(j)$ across the network be maximized: this suggests that load-balancing would help improve the acceptance rate.

Table 1 Transition matrix and steady state probabilities for the system described in Example 2 of Sect. 3B.5

State	0	1	2	3	Probability
0	0	2λ	λ	0	$\frac{1}{(1+2\rho)(1+\rho)}$
1	μ	0	0	2λ	$\frac{2\rho}{(1+2\rho)(1+\rho)}$
2	μ	0	0	0	$\frac{\rho}{(1+2\rho)(1+\rho)}$
3	0	2μ	0	0	$\frac{2\rho^2}{(1+2\rho)(1+\rho)}$

- If all the nodes are within the transmission range of one another (all communications are single-hop), then the upper and lower bounds (Eqs. 11 and 17) converge with $\rho_k(j) = N \frac{\lambda_k}{\mu_k}$.
- To ensure that the call acceptance is always above a certain threshold irrespective of the load, Eqs. 17 and 18 indicate that the network must be well-provisioned i.e., B must be sufficiently high.
- The Eqs. 22–25 suggest that the call acceptance decreases with bandwidth requirement and system load, this decrease being rapid at high loads.
- As boundary cases, the following are seen to hold for the call acceptance rates: As the number of slots increases, it tends to unity. As the call duration increases, it approaches zero.

(7) *The case when the interference range is not equal to the transmission range:* In this section, we relax the assumption that the interference range of a node is equal to the transmission range. Nodes that lie within the transmission range of a node j can send packets to and receive packets from node j . On the other hand, a node that lies in the interference range of node j but outside the transmission range can disrupt communication involving node j in a slot by transmitting in the same slot, although they typically cannot communicate reliably with node j itself. We denote the interference range by Q and the transmission range by R . When $Q > R$, we now have nodes that lie outside the transmission range of a node j that can interfere with the communication involving node j . This reduces the spatial reuse of slots. The decrease in spatial reuse is indicated by an increase in the constant c introduced in Sect. 3A. If the paths chosen for routing are such that, less than c consecutive nodes on the path lie within the interference range of one another, then the call can be routed along the path using at most c slots. Here, we estimate c as a function of Q and R . Thus, for the more general case of $Q > R$, our earlier analysis can be carried through using the appropriate c and by replacing the notion of transmission range with that of interference range.

We maintain the earlier assumption that for three nodes A, B, C that are within distance R of one another, calls will always be routed from A to C along the direct link (A, C) instead of links (A, B) and (B, C) . Consider a path consisting of nodes $(1, 2, \dots, \phi)$. We denote the distance between two nodes (i, j) as $d(i, j)$. We want to place these ϕ nodes so that

$$d(i, i + 1) \leq R, \quad i \in \{1, 2, \dots, \phi - 1\} \tag{26}$$

$$R(1 + \delta) \leq d(i, j) \leq Q, \quad j \notin \{i, i - 1, i + 1\}, i \in \{1, 2, \dots, \phi\} \tag{27}$$

$$R(1 + \delta) \leq d(1, \phi) \leq Q \tag{28}$$

Here δ is a small positive constant and we need $Q \geq R(1 + \delta)$. These constraints ensure that the consecutive

nodes on the path $(i, i + 1), i \in \{1, 2, \dots, \phi - 1\}$ can communicate, the non-consecutive nodes cannot communicate, and that any pair of nodes can interfere with one another.

To construct ϕ such points, consider a regular polygon of $\phi + 1$ points with the nodes $\{1, 2, \dots, \phi\}$ mapped to consecutive points of the polygon (except the point $\phi + 1$ which has no node mapped to it). Let r be the radius of the circumcircle of this polygon. Then the distance between consecutive nodes $d(i, i + 1) = 2r \sin \frac{\pi}{\phi + 1} \leq R$. The distance between non-consecutive nodes $d(i, j) \geq 2r \sin \frac{2\pi}{\phi + 1} \geq R(1 + \delta)$. The maximum distance between any pair of nodes $2r \sin \left(\frac{\pi}{\phi + 1} \lfloor \frac{\phi + 1}{2} \rfloor \right) = Q$. Combining these three constraints

$$\frac{\sin \left(\frac{\pi}{\phi + 1} \right)}{\sin \left(\frac{\pi}{\phi + 1} \lfloor \frac{\phi + 1}{2} \rfloor \right)} \leq \frac{R}{Q} \leq \frac{1}{1 + \delta} \frac{\sin \left(\frac{2\pi}{\phi + 1} \right)}{\sin \left(\frac{\pi}{\phi + 1} \lfloor \frac{\phi + 1}{2} \rfloor \right)} \tag{29}$$

We are interested in the maximum value of $\phi + 1$. This gives us the value of the parameter c for the given ratio $\frac{Q}{R}$. To see this, consider a call whose path includes the path from 1 to ϕ i.e., the call arrives at node 1 from some node $j \notin \{1, 2, \dots, \phi\}$, follows the path $\{1, 2, \dots, \phi\}$, and then is transmitted from node ϕ to some node $k \notin \{1, 2, \dots, \phi\}$. Say node 1 receives the call on slot 1. Each of the links $(i, i + 1), i \in \{1, 2, \dots, \phi - 1\}$ must use a different slot, say $i + 1$, because these nodes interfere with each other. Finally node ϕ transmits the call to node k on slot $\phi + 1$ due to interference from the remaining nodes in slots $\{1, 2, \dots, \phi\}$. Thus

$$c = \arg \max_{\phi} \left(\frac{\sin \left(\frac{2\pi}{\phi + 1} \right)}{\sin \left(\frac{\pi}{\phi + 1} \lfloor \frac{\phi + 1}{2} \rfloor \right)} \geq \frac{R(1 + \delta)}{Q} \right) \tag{30}$$

The dependence of c on the ratio $\frac{Q}{R}$ is shown in Fig. 7. We see from the figure that for the common case when the

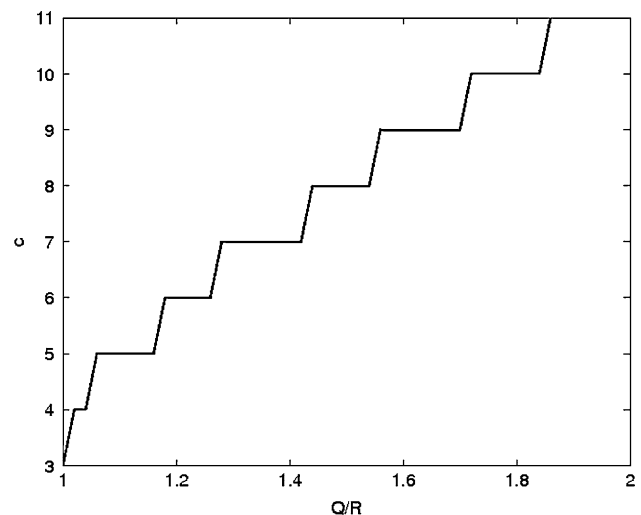

Fig. 7 The dependence of the parameter c on the ratio of the interference range to the transmission range $\left(\frac{Q}{R}\right)$

interference range is not much bigger than the transmission range, c is at most 6.

(8) *The failure of shortest-path routing:* The analysis tells us that the parameters, the call acceptance probability and the system saturation probability depend on the load on the network, the hopcount of the path, and the routing protocol. We first look at the performance of shortest-path routing relative to the theoretical guarantees. The routing protocol is related to the call acceptance and the system saturation probability through the factor $f_k(i, j)$ specified in Eq. 1.

Shortest-path routing: Shortest-path routing computes the shortest-path between the source and the destination where the distance refers to the Euclidean distance between the nodes. In a highly dense network, the authors of [15] proved that the average path length obtained when shortest-path routing is employed is $0.905R$ where R is the radius of the network. This leads to heavier load at the center region of the network. We simulate shortest-path routing and measure the call acceptance rate. The Figs. 8 and 9 indicate the loading of the center of the network, and decreasing load away from the center where the ring can be regarded as a unit of distance from the center (refer Sect. 5 for more details). The Figs. 10–12 show that the shortest-path routing has a call acceptance rate much below the theoretical limit. Note that even in Fig. 10, the system has several calls with varying hops, which would be the case in a realistic scenario. The results shown in Figs. 10–12 are got by measuring the acceptances for single-hop, 2-hop, and 3-hop calls, respectively. The reason that shortest-path routing performs badly is due to the fact that a majority of the calls are routed through the center of the network resulting in a high load in the center. This problem suggests

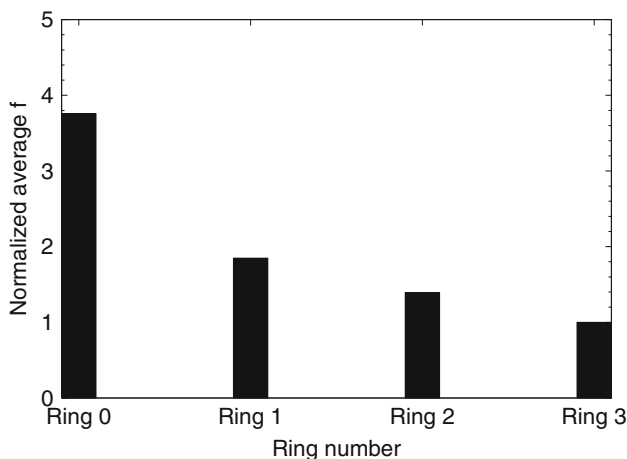

Fig. 8 The normalized average fraction of calls being routed to a node with increasing distance from the center for shortest-path routing. The arrival rate is 0.04 call per second at a node

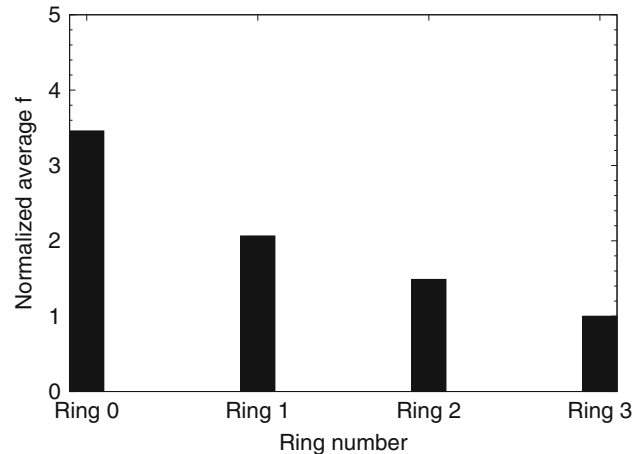

Fig. 9 The normalized average fraction of calls being routed to a node with increasing distance from the center for shortest-path routing. The arrival rate is 1 call per second at a node

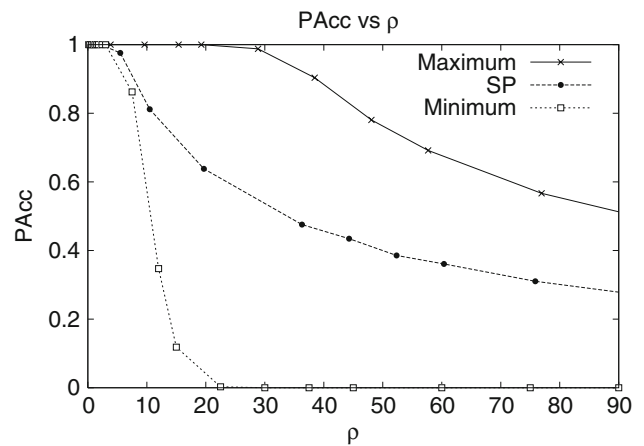

Fig. 10 Call acceptance of single-hop calls using shortest-path routing versus varying load

the use of load-balancing to alleviate the formation of hotspots and to increase the call acceptance.

(C) *Deterministic guarantees:* Our aim is to ensure that a certain number of calls in the network can be assured of acceptance. We can do so by pegging these calls at a high priority. Consider the following *rank-based priority scheme*: (Fig. 13) Calls are prioritized according to the classes to which they belong. In addition, calls that belong to the highest priority are further allocated to sub-classes which are based on the address or ID of the source of the call. Further, call admission ensures that only one call of a given sub-class exists in the system. This implies that a particular node can originate only one such highest priority call. Preemption is permitted amongst the sub-classes themselves so that a high-priority sub-class has a better chance of acceptance. Hence a scenario can be envisaged as follows: the network is deployed in a military scenario in

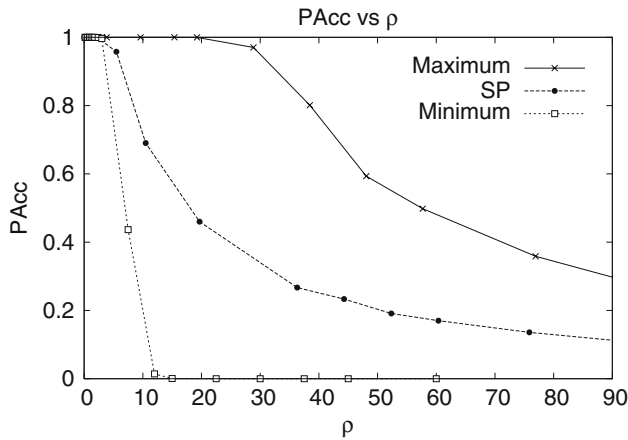

Fig. 11 Call acceptance of 2-hop calls using shortest-path routing versus varying load

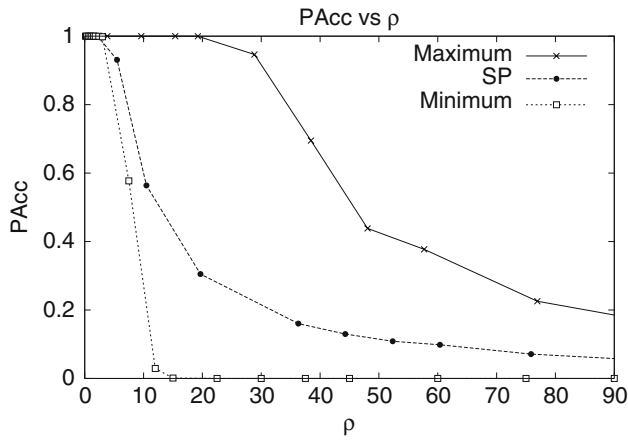

Fig. 12 Call acceptance of 3-hop calls using shortest-path routing versus varying load

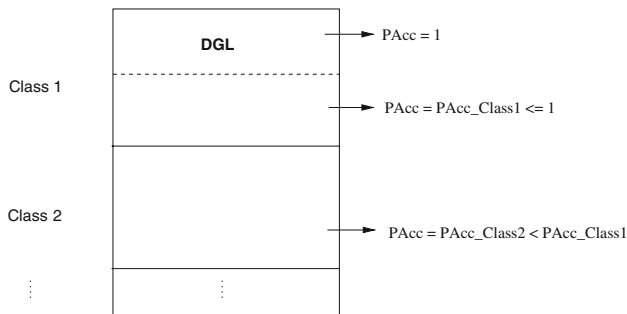

Fig. 13 Rank-based priority scheme

which the nodes are under the control of various communicating officers. The node ID can be assigned based on the rank of the officer using the node. Calls are prioritized at the time of call admission into various classes. These calls then have probabilities of acceptance depending on the

class to which they have been assigned and the network state. In addition, the calls of the highest priority class are assigned to sub-classes based on their node ID. Thus, to ensure that the call of the highest-ranking officer (say the General) always gets through, the general’s node would be assigned a high-priority node ID. Thus, a set of nodes can be designated to ensure certain call acceptance. To ensure that these guarantees provided are effective, we need to estimate the number of calls (which is equivalent to the number of sub-classes) for which certain call acceptance can be ensured, and the call acceptance for the sub-classes which lie outside the former class.

(1) *Deterministic Guarantee Limit*: The *Deterministic guarantee limit* D refers to the number of sub-classes of the highest priority class that can be ensured deterministic call acceptance as outlined at the beginning of this section. These sub-classes are referred to as the deterministic sub-classes. From

$$\begin{aligned} \text{Number of calls in } R(j) &= x \\ \Rightarrow \text{Number of used slots in } R(j) &\leq cx \end{aligned} \tag{31}$$

If $x = \lfloor \frac{B}{c} \rfloor$, then the number of used slots in $R(j) \leq B$. If the total number of sub-classes in the network = $\lfloor \frac{B}{c} \rfloor$, then for every node j , the number of used slots in $R(j) \leq B$. Thus, this is the number of sub-classes that can be definitely accepted by every region of the network at a given time. By allocating a unique set of slots to each of the $\lfloor \frac{B}{c} \rfloor$ sub-classes, we can ensure that calls of these sub-classes are accepted (of course, any lower priority calls may need to be preempted in the process). Thus, the Deterministic guarantee limit $D \geq \lfloor \frac{B}{c} \rfloor$. This implies that $\lfloor \frac{B}{c} \rfloor$ sub-classes can be ensured deterministic call acceptance. However, this being a lower bound it may be possible for some more sub-classes to be ensured of this deterministic acceptance.

Independence of the guarantee limit and mobility: At this point, we also would like to point out the effect of the mobility of the nodes on the limit. The deterministic guarantee limit is independent of the mobility. The set of sub-classes $\{1, \dots, \lfloor \frac{B}{c} \rfloor\}$ are ensured of deterministic acceptance even in the face of node mobility. Mobility in the network leads to path breaks and, subsequent, route reconfiguration attempts. In any such attempt, the calls belonging to the deterministic sub-classes retain their priority. Thus, these calls are guaranteed resources during the reconfiguration.

(2) *Probability of acceptance for the probabilistic sub-classes*: The sub-classes other than the deterministic sub-classes are referred to as the probabilistic sub-classes. Since sub-classes are assigned based on node IDs, there are N sub-classes, designated $\{1, \dots, N\}$ in decreasing order of

priority. We are considering the call acceptance of a call belonging to a sub-class $n > \lfloor \frac{B}{c} \rfloor$ (all calls in any of the sub-classes $\{1, \dots, \lfloor \frac{B}{c} \rfloor\}$ are of a higher priority than this call and are within the deterministic guarantee limit) at a time t . We denote the probability that a call of sub-class i exists in the network at time t by $p_i(t)$.

Let $q_i(t) = 1 - p_i(t)$. Denote: the acceptance of call of sub-class n as ACC_n , and the number of calls \in sub-classes $\{1, \dots, n - 1\}$ as $Count(1, n - 1)$. As in Eq. 31, if $Count(1, n - 1)$ is less than $\lfloor \frac{B}{c} \rfloor$, then for every node j , the number of slots used by calls of these sub-classes is $\leq B - c$. All the remaining c slots are either free or are used by lower-priority calls which can be preempted by the call belonging to sub-class n . Thus, the call of sub-class n can be accepted. Thus

$$\begin{aligned} \text{At time } t, Count(1, n - 1) < \lfloor \frac{B}{c} \rfloor \\ \Rightarrow \text{Call of sub-class } n \text{ is accepted} \end{aligned} \tag{32}$$

$$\begin{aligned} P\left(\text{Call of sub-class } n \text{ is accepted} \mid Count(1, n - 1) < \lfloor \frac{B}{c} \rfloor\right) \\ = 1 \end{aligned} \tag{33}$$

By denoting the probability of acceptance of the call belonging to sub-class n at time t as $P_n(t)$:

$$\begin{aligned} P_n(t) = & P\left(ACC_n \mid Count(1, n - 1) < \lfloor \frac{B}{c} \rfloor\right) \\ & \times P\left(Count(1, n - 1) < \lfloor \frac{B}{c} \rfloor\right) \\ & + \left[P\left(ACC_n \mid Count(1, n - 1) \geq \lfloor \frac{B}{c} \rfloor\right) \right. \\ & \left. \times P\left(Count(1, n - 1) \geq \lfloor \frac{B}{c} \rfloor\right) \right] \end{aligned} \tag{34}$$

$$\begin{aligned} P_n(t) \geq & P\left(Count(1, n - 1) < \lfloor \frac{B}{c} \rfloor\right) \\ P_n(t) \geq & \sum_{S \subseteq \{1, \dots, n-1\} \mid |S| \leq \lfloor \frac{B}{c} \rfloor} \prod_{l \in S} p_l(t) \prod_{r \in \{1, \dots, n-1\} - S} q_r(t) \end{aligned} \tag{35}$$

When the calls at each node follow an identical probability distribution i.e., $p_j(t) = p(t), \forall j \in \{1, \dots, N\}$, Eq. 35 simplifies to

$$P_n(t) \geq \sum_{i=0}^{i=\lfloor \frac{B}{c} \rfloor} \binom{n-1}{i} p(t)^i q(t)^{n-i-1} \tag{36}$$

4 Load-balancing

We consider the following strategies for load-balancing:

- *Ring-based routing*: Ring-based routing [15] transfers the load from the center to the periphery of the network.

The scheme makes use of heuristics to balance the load. We define the following terms:

- The center node or center of a network, C , is the node for which,

$$\max_{\forall x} (HC(C, x)) \leq \min_{\forall y} (\max_{\forall z} (HC(y, z)))$$

for all nodes x, y , and z in the network.

Here $HC(a, b)$ denotes the hopcount of the shortest path from node a to node b .

- Each node in the network belongs to a *Ring* denoted by $Ring_i(r_i, r_{i+1})$. A *Ring* is an imaginary division of the network into concentric rings about the center of the network. The thickness of the ring is given by $r_{i+1} - r_i$. A node that belongs to $Ring_i$ lies at a distance in (r_i, r_{i+1}) from the center of the network.

- The load balancing heuristic that we use is a Preferred Outer Ring routing Scheme (PORS) [15]. In this strategy, traffic generated in a node in $Ring_i$ and destined for a node in $Ring_j$ must not go beyond the rings enclosed by $Ring_i$ and $Ring_j$. Further, the packets must be preferentially routed through the outer of the two rings. Thus, for nodes belonging to the same ring, packets must be preferentially transferred in the same ring. For nodes belonging to different rings, all angular transmissions must preferentially take place in the outer of the two rings while the radial transmissions transfer packets across the rings. Thus, PORS affects the hopcount while at the same time moving most of the load away from the center.
- *Bandwidth-limited routing*: Bandwidth-limited routing is a more direct form of load-balancing that uses an estimate or measurement of the available bandwidth to select a path. It differs from the two previous methods (shortest-path routing and PORS) in that it is dynamic: constantly adapting to changes in the network state. There are two opposing metrics that such a scheme attempts to reconcile. It tries to choose paths with the highest available bandwidth. These paths, usually, tend to be longer than the shortest path. As a result, the available bandwidth of the path, which is the minimum of the available on the constituent links, is more likely to decrease.

The scheme that we use is based on the Shortest-dist (P, n) studies in [16]. We use a variant of this heuristic. The weight for the link (u, v) is weighted by $\frac{1}{B(u,v)^n}$ where $B(u, v)$ is the estimated bandwidth of the link, and n is a weighting factor. We simply estimate this as the minimum of the number of free slots at nodes u and v . The intuition behind this heuristic is that when the links are weighted thus, shortest-path routing will select a path that minimizes $\sum_{i=1}^{i=k} \frac{d_i}{B_i^n}$ where k is the

number of hops, d_i is the Euclidean distance of the i th hop, and B_i is the estimated bandwidth of the link traversed on the i th hop. This heuristic tends to select links with high available estimated bandwidth that would also form a short path to the destination. We set the exponent n to 1 for our experiments.

5 Simulation studies

To study the actual behavior of the parameters of interest, we built a TDMA based Ad hoc wireless network simulator in C++. Our simulator models the wireless system described in Sect. 3A and B by taking into account the broadcast nature of wireless medium, in the same way as the well known simulators such as NS-2 and QualNet model the wireless networks. Unlike these simulators, our simulator lacks any modeling of *radio propagation path-loss* and *fading* effects in wireless environment. However, as our objective in this work is to study the influence of routing protocols on the call acceptance rate, which is a measure of the number of calls that can be admitted into the network, our work does not involve collecting any results after a call is established. The call acceptance measurement is performed by the call admission control module while admitting calls into the network. Hence the results presented in this paper do not get affected by actual packet exchanges in the network. But metrics such as call drop ratio, packet delivery ratio, and end-to-end delay involve collecting measurements after calls get admitted into the network and hence require sophisticated simulators like NS-2 and QualNet implement radio propagation models in wireless environment.

Call admission involves two steps: finding a path using one of the routing protocols discussed and reserving slots along the path. Slot allocation for a particular call is done in a greedy manner. If at any intermediate node, the number of free slots is found to be inadequate, the call is rejected. Calls are generated at each node according to a Poisson process and the accepted calls have an exponentially distributed call duration. The nodes are not mobile. The parameters of the simulation are specified in Table 2. The simulated network has 50 nodes which are distributed in a uniformly random fashion over a terrain of 1,000 m × 1,000 m. Transmission range of a node is 300 m. Interference range of a node is equal to its transmission range. For each call the destination node is chosen uniformly at random from all other nodes present in the network. Simulation runs are carried out for 20 seeds and each simulation run is for a duration of 200 s.

For the simulation studies, we vary the load by varying the call arrival rate at each node. We compare the call acceptance probabilities for varying values of

Table 2 Parameters used in the simulation

Parameter	Value
Number of nodes	50
Number of slots	32
Terrain area	1,000 m × 1,000 m
Transmission range	300 m
Average call duration	30 s
Simulation duration	200 s
Number of seeds	20

$\rho = (\text{Average Call Arrival Rate}) \times (\text{Average Call Duration})$. In order to compare the theoretical values and the experimental results, we need to translate the ρ value to the $\rho_{1,v}^{Max}$ value. Thus, we also measure the average fraction of calls that pass through a region. This factor is an indication of the nature of the routing protocol used. We then measure the call acceptance of calls based on their hopcount for different routing protocols and compare with the theoretical limits.

6 Simulation results

(A) *Call acceptance probability*: We have compared the probability of call acceptance of shortest-path routing (SP), Bandwidth-limited routing (BW), PORS, and the theoretical bounds at different values of load (in terms of ρ). We have also studied the acceptance probability for hopcount values of 1, 2, and 3 (Figs. 14–16). In all the results, the call acceptance probability value decreases with an increase in the network load, as expected. Further, the curves depicting the call acceptance probability values of SP, BW, and PORS lie within the region surrounded by P_{Acc}^{Max} and P_{Acc}^{Min} .

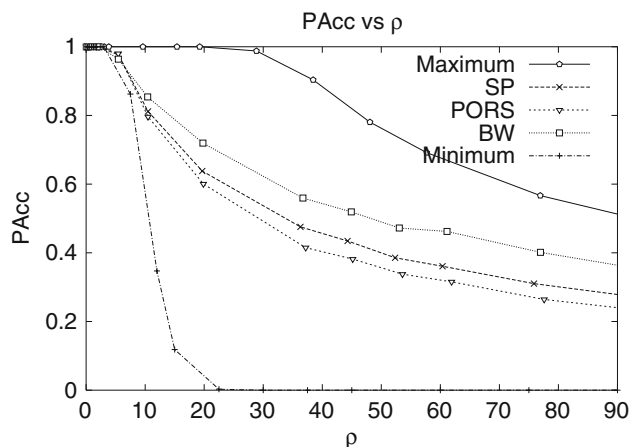

Fig. 14 Variation of Call Acceptance versus ρ for Single-hop calls

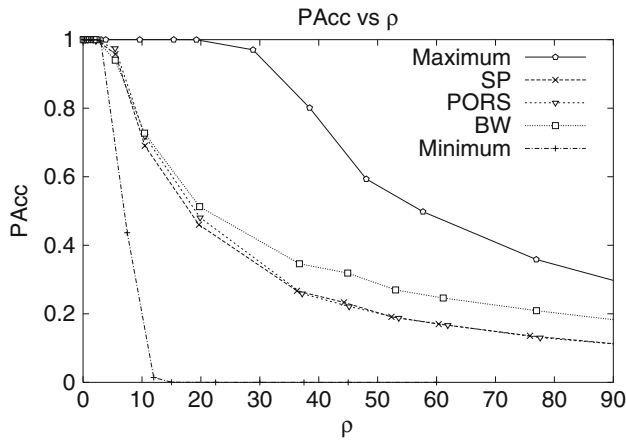

Fig. 15 Variation of Call Acceptance versus ρ for 2-hop calls

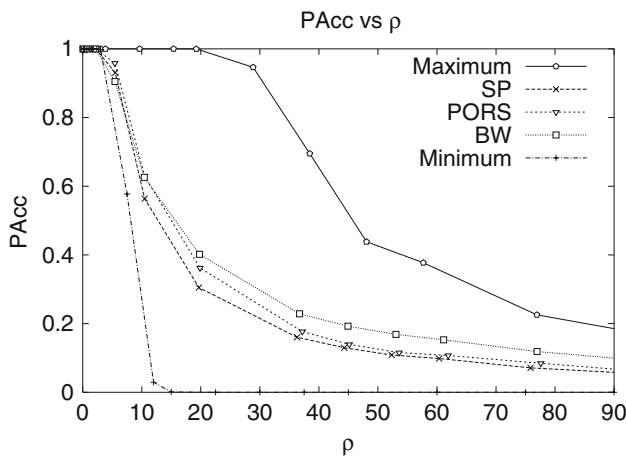

Fig. 16 Variation of Call Acceptance versus ρ for 3-hop calls

PORS performs only marginally better than shortest-path routing (and in fact worse for single-hop calls) while BW performs significantly better. PORS attempts to balance the load implicitly by routing calls to the periphery: this may not be the most effective strategy because nodes in one ring can interfere with those in other rings. Also it does not take into account the fact that a longer path would result in more resources being consumed affecting the acceptance rate of calls in the future. This is probably the reason why the single-hop calls have a lower acceptance rate in PORS. BW, by using an explicit bandwidth-based load-balancing is evidently more effective. To bring out the difference in the performance of the three routing algorithms, we compute the fraction of all generated calls that arrive at a node. We compute the average of this fraction for all nodes that belong to a ring and hence can be considered to be at a fixed distance from the center of the network. The Figs. 17 and 18 plot this average fraction (normalized so that the least number is 1 and all the others are divided by this least number) for two different loads on

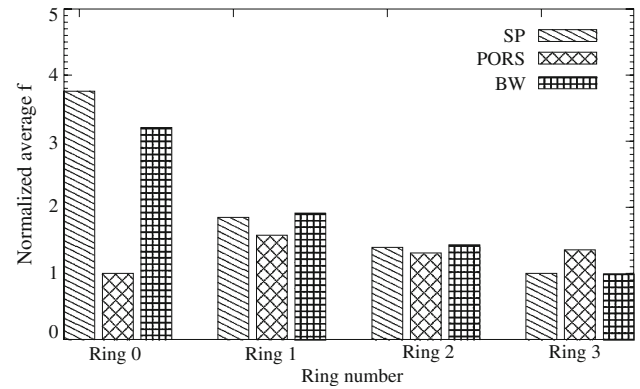

Fig. 17 The normalized average fraction of calls being routed to a node with increasing distance from the center. The arrival rate is 0.04 call per second at a node

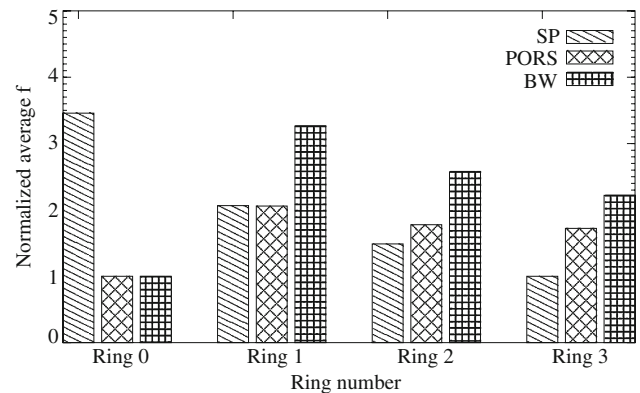

Fig. 18 The normalized average fraction of calls being routed to a node with increasing distance from the center. The arrival rate is 1 call per second at a node

the network. In both cases, shortest-path routing has a high load near the center. PORS shifts this load to the periphery but incurs the cost of higher path length. BW behaves like shortest-path when the network is lightly loaded but shifts the calls to the periphery with an increasing load. The difference between the theoretical upper bound and the experimental results is partly the result of the approximations and assumptions used in our model. However, the difference also reflects the inadequacy of the existing protocols in load-balancing.

The increase in the call acceptance probability of the load-balancing schemes as compared to shortest-path routing indicates the importance of load-balancing in ensuring better throughput in terms of call acceptance. In fact, load-balancing seems to be an important method of approaching P_{Acc}^{Max} . The results indicate that an ideal load-balancing based routing protocol can come close to the theoretical upper bound.

(B) System saturation probability: The variation of the probability of system saturation with load is shown in

Fig. 19. This metric remains near zero for moderate-to-heavy loads, and takes on an appreciable value only at high values of load. This indicates that system saturation is a rare occurrence for the common values of load. Thus, the network rarely enters a state where every new call is rejected. This also implies that for the common values of load, it is always possible to ensure that some fraction of the calls are guaranteed acceptance. This fraction is based on the values of the probability of call acceptance at that load.

(C) *Calls with varying bandwidth:* We now consider the case where the calls have varying bandwidth requirements as discussed in Sect. 3B.4. The channel capacity is 54 Mbps and slottime is 1 ms. We consider 3 classes of multimedia calls in the network (i.e., $K = 3$). Class 1 calls require 54 Kbps (i.e., $b = 1$, voice calls), class 2 calls require 108 Kbps (i.e., $b = 2$, low-quality video calls), class 3 calls require 162 Kbps (i.e., $b = 3$, medium-quality video calls). The total number of slots available in the

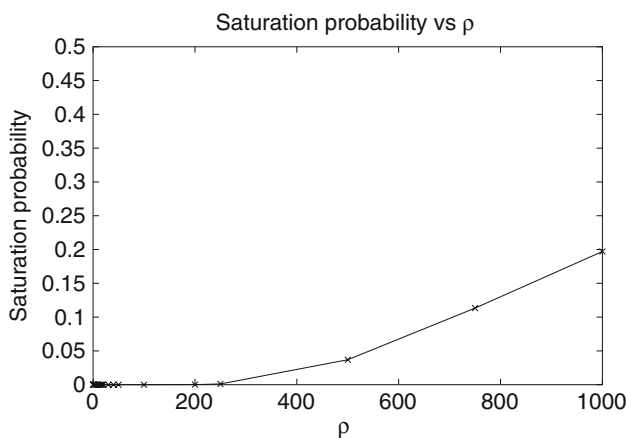

Fig. 19 Variation of Saturation Probability versus ρ

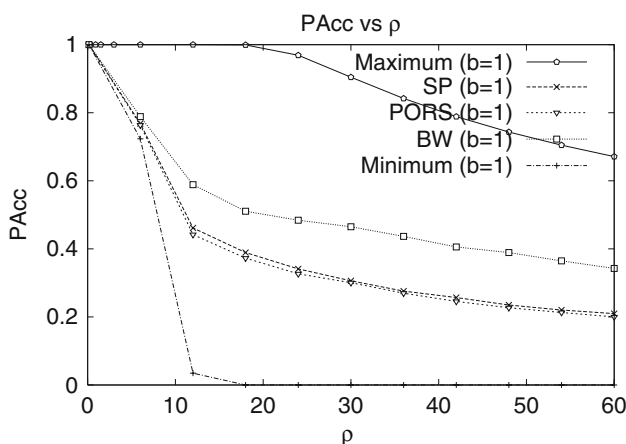

Fig. 20 Call acceptance probability of Single-hop calls ($b = 1$) versus varying load

network is 150, (i.e., $B = 150$). We assume that the load (ρ) is same for all classes of calls. We measure the call acceptance probability of calls based on their class and hopcount for SP, PORS, and BW protocols at varying values of ρ and compare with the theoretical limits.

The Figs. 20–28 show the variation of the call acceptance probability versus load for hopcount values of 1, 2, and 3. In all the protocols, the call acceptance probability decreases with an increase in the bandwidth (in terms of number of slots, b) requirement from Class 1 calls to Class 3 calls. As observed from the plots, the call acceptance probability decreases more rapidly for multi-hop calls present in the network. Since it employs explicit bandwidth-based load-balancing in the network, BW routing protocol out-performs other two routing protocols. As observed from the plots, the curves depicting the call acceptance probability values for all 3 classes of calls in the case of SP, PORS, and BW routing protocols lie within the region surrounded by P_{Acc}^{Max} and P_{Acc}^{Min} .

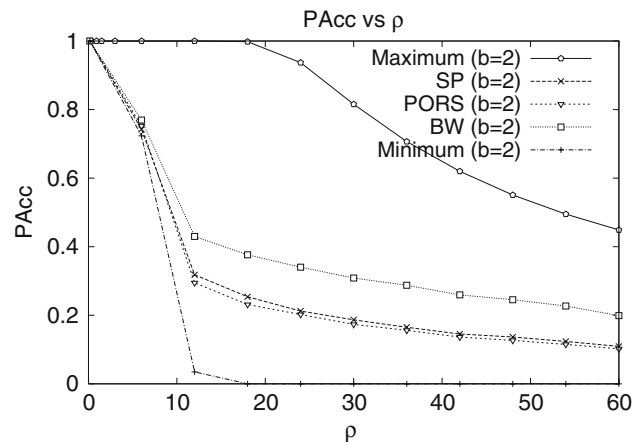

Fig. 21 Call acceptance probability of Single-hop calls ($b = 2$) versus varying load

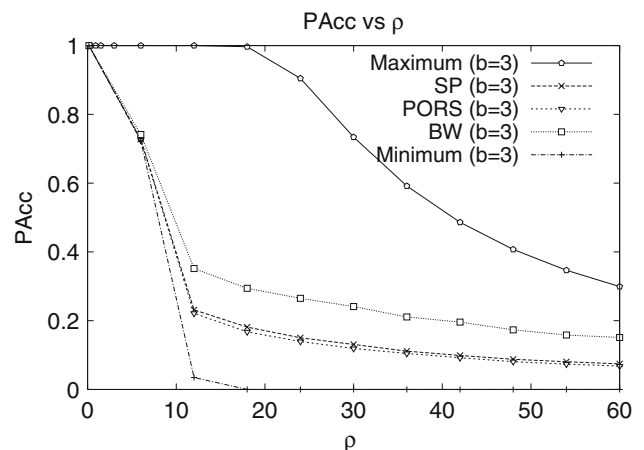

Fig. 22 Call acceptance probability of Single-hop calls ($b = 3$) versus varying load

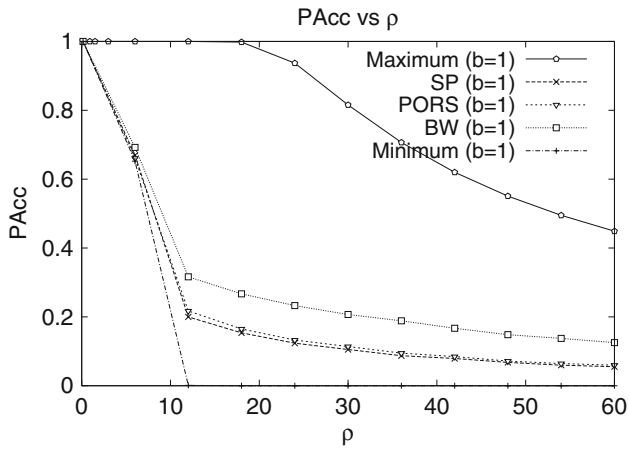

Fig. 23 Call acceptance probability of 2-hop calls ($b = 1$) versus varying load

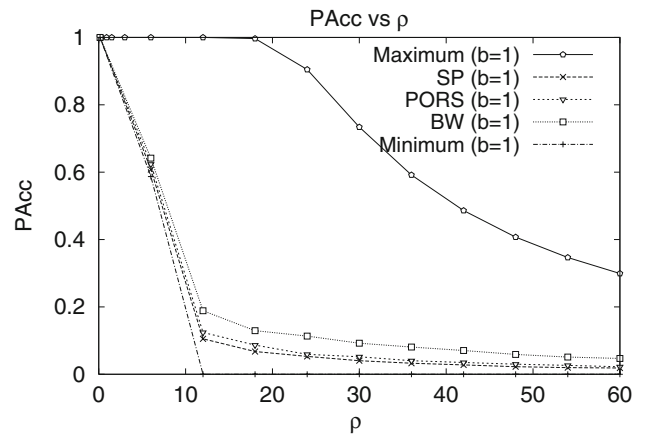

Fig. 26 Call acceptance probability of 3-hop calls ($b = 1$) versus varying load

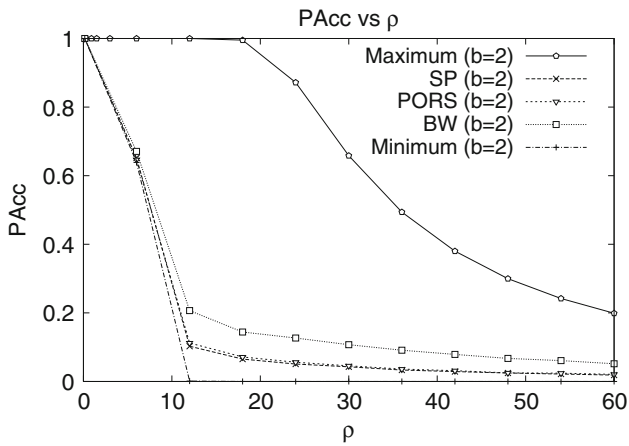

Fig. 24 Call acceptance probability of 2-hop calls ($b = 2$) versus varying load

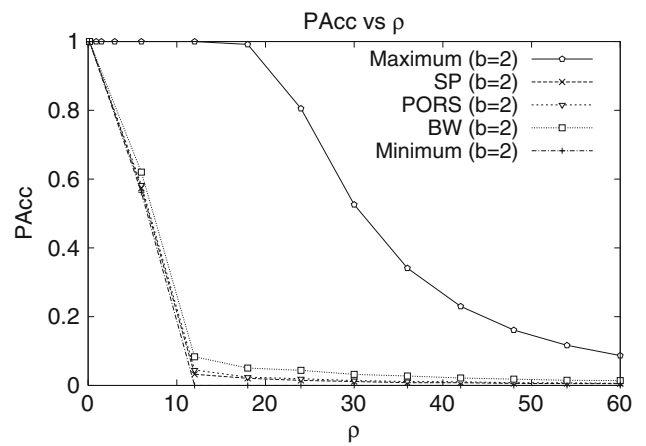

Fig. 27 Call acceptance probability of 3-hop calls ($b = 2$) versus varying load

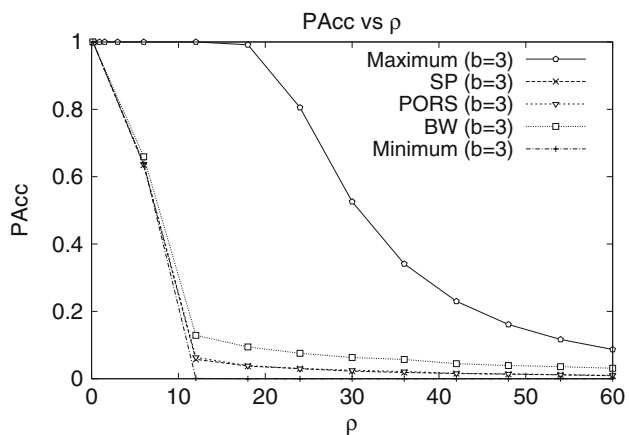

Fig. 25 Call acceptance probability of 2-hop calls ($b = 3$) versus varying load

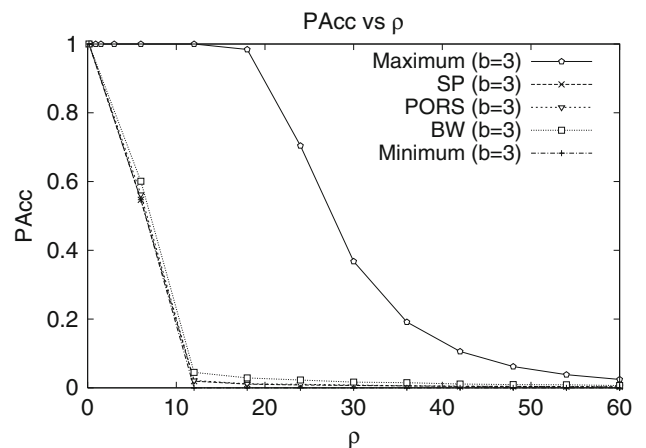

Fig. 28 Call acceptance probability of 3-hop calls ($b = 3$) versus varying load

7 Conclusion and future directions

A realistic analysis of the nature of QoS guarantees is crucial in the design of new protocols and the improvement of existing ones to handle the growing diversity of demands on networks. In this paper, we have analyzed a TDMA based Ad hoc wireless network. We have derived an upper bound on the probability of call acceptance: a bound that gives us a measure of the number of calls that can be allowed into the network, and a lower bound on the probability of system saturation: a number that indicates the likelihood of the network being unable to accept any further calls. Our analysis takes into consideration the behavior of the routing protocol and the inter-dependence of resources (time-slots) of neighboring regions in a wireless network. Further, our simulation studies indicate that the set of protocols tested fall short of the established bounds. Amongst the three protocols compared, the one that incorporated load-balancing out-performed the shortest-path routing based protocol. This clearly indicates the importance of load-balancing in the attainment of high network performance, and the provision of better QoS guarantees.

We have estimated the deterministic guarantee limit. This limit indicates that it is always possible to ensure QoS guarantees for a certain sub-class of calls (the sub-class being a function of the node ID of the source of the call) irrespective of the mobility and resource constraints of the network.

One of the key limitations of our analysis is our assumption that nodes are not mobile. When the nodes are moving, the number of nodes in a given region becomes time-dependent. This in turn is reflected in the factor ρ becoming time-independent. We would like to study the effect of time-dependence of ρ on the call acceptance. The experimental studies also need to be extended to compare other protocols to infer the essential and desirable properties of protocols that approach optimal-behavior. This will also serve as a guideline in the design of protocols that attempt to meet specific QoS guarantees. Secondly, the current bounds that we have derived are not tight. Closing the gap between analysis and simulations will provide further insights into the limits on the capacity of wireless networks.

A main scope for future work arises from our consideration of the call acceptance problem in the TDMA setting. While attempting to provide bandwidth guarantees in wireless networks, two important problems arise. The first is the call acceptance in the presence of contention for the system resources. The other important problem is call

dropping in the presence of changes in the configuration of the system, due to issues such as interference and node mobility. While this work has only considered the former problem, the ability to provide QoS guarantees relies on accurately modeling both problems in a unified framework. Extending our analysis to non-TDMA wireless networks is another interesting avenue for further research.

References

- Gupta, P., & Kumar, P. R. (2000). The capacity of wireless networks. *IEEE Transactions on Information Theory*, 46(2), 388–404.
- Xie, L. L., & Kumar, P. R. (2004). A network information theory for wireless communication: Scaling laws and optimal operation. *IEEE Transactions on Information Theory*, 50(5), 748–767.
- Grossglauser, M., & Tse, D. N. C. (2002). Mobility increases the capacity of ad hoc wireless networks. *IEEE/ACM Transactions on Networking*, 10(4), 477–486.
- Tabet, T., & Knopp, R. (2004). Bounds on the throughput capacity of wireless ad hoc networks with non-uniform traffic. In *Proceedings of IEEE SECON*, pp. 210–217, October 2004.
- Negi, R., & Rajeswaran, A. (2004). Capacity of power constrained ad-hoc networks. In *Proceedings of IEEE INFOCOM*, Vol. 1, pp. 443–453, March 2004.
- Kumar, A., Altman, E., Miorandi, D., & Goyal, M. (2005). New insights from a fixed point analysis of single cell IEEE 802.11 wireless LANs. In *Proceedings of IEEE INFOCOM* Vol. 3, pp. 1550–1561, March 2005.
- Sharma, G., Ganesh, A., & Key, P. (2006). Performance analysis of contention based medium access control protocols. In *Proceedings of IEEE INFOCOM*, April 2006.
- Gao, Y., Chiu, D.-M., & Lui, J. C. S. (2006). Determining the end-to-end throughput capacity in multi-hop networks: Methodology and applications. *ACM SIGMETRICS Performance Evaluation Review*, 34(1), pp. 39–50.
- Romer, K. (2001). Time synchronization in ad hoc networks. In *Proceedings of ACM MOBIHOC*, pp. 173–182, October 2001.
- Zhong, X., Mei, S., Wang, Y., & Wang, J. (2004). Synchronization in TDMA ad hoc network. In *Proceedings of IEEE VTC* Vol. 7, pp. 5011–5014, September 2004.
- Chen, L., & Leneutre, J. (2007). Toward secure and scalable time synchronization in ad hoc networks. *Computer Communications*, 30(11–12), 2453–2467.
- Kemeny, J. G., & Snell, J. L. (1960). *Finite Markov chains*. New York, USA: Van Nostrand.
- Buchholz, P., Ciardo, G., Kemper, P., & Donatelli, S. (2000). Complexity of memory-efficient Kronecker operations with applications to the solution of Markov models. *INFORMS Journal on Computing*, 12(3), 203–222.
- Bertsekas, D., & Gallager, R. (1992). *Data networks*, 2nd edn. New Jersey, USA: Prentice Hall.
- Bhaya, G., Manoj, B. S., & Siva Ram Murthy, C. (2003). Ring-based routing schemes for load distribution and throughput improvement in multi-hop cellular, ad hoc, and mesh networks. In *Proceedings of HiPC*, LNCS 2913, pp. 152–161, December 2003.
- Ma, Q., Steenkiste, P., & Zhang, H. (1996). Routing high-bandwidth traffic in max–min fair share networks. In *Proceedings of ACM SIGCOMM*, pp. 206–217, August 1996.

Author Biographies



S. Sriram obtained his B.Tech. degree in Computer Science and Engineering in 2004 from the Indian Institute of Technology (IIT), Madras, India. He is currently working towards the Ph.D. degree in the department of Computer Science at the University of California, Berkeley, USA. His research interests include Wireless networks, Distributed systems, Network security, and Computational biology.



T. Bheemarjuna Reddy received the B.Tech. degree in Computer Science and Engineering from Andhra University, India, in 2000 and the M.E. degree in Computer Science and Engineering from the National Institute of Technology (NIT), Rourkela, India, in 2002. He was an iNautix doctoral student during 2002–2006 in the Department of Computer Science and Engineering at the Indian Institute of Technology (IIT) Madras, India, where he focused on QoS provisioning and Multimedia transport in Ad hoc wireless networks.

During January 2007–March 2007, he was a Senior Project Officer at IIT Madras, India. He is currently a post-doctoral researcher at the University of California, San Diego, USA. His research interests include Quality of Service, Multimedia transport, and Cognitive networking in wireless networks.



C. Siva Ram Murthy earned his B.Tech. degree in Electronics and Communication Engineering from Regional Engineering College (now National Institute of Technology), Warangal, India, in 1982, M.Tech. degree in Computer Engineering from the Indian Institute of Technology (IIT), Kharagpur, India, in 1984, and Ph.D. degree in Computer Science from the Indian Institute of Science, Bangalore, India, in 1988. He has been with the Department of Computer Science

and Engineering at IIT Madras, since 1988, where he is currently a Professor. He has held visiting positions at the German National Research Centre for Information Technology (GMD), Germany, University of Stuttgart, Germany, University of Freiburg, Germany, Max Planck Institute for Software Systems, Germany, Swiss Federal Institute of Technology (EPFL), Switzerland, University of Washington, Seattle, USA, and University of California San Diego, USA. He is the co-author of the textbooks *Parallel Computers: Architecture and Programming*, (Prentice-Hall of India, New Delhi, India), *New Parallel Algorithms for Direct Solution of Linear Equations*, (John Wiley & Sons, Inc., New York, USA), *Resource Management in Real-time Systems and Networks*, (MIT Press, Cambridge, USA), *WDM Optical Networks: Concepts, Design, and Algorithms*, (Prentice Hall, New Jersey, USA), and *Ad Hoc Wireless Networks: Architectures and Protocols*, (Prentice Hall, New Jersey, USA). His research interests include parallel and distributed computing, real-time systems, lightwave networks, and wireless networks. He has published over 125 papers in refereed international journals and over 125 papers in refereed international conferences in these areas. Dr. Murthy is a recipient of Best Ph.D. Thesis Award from the Indian Institute of Science, Indian National Science Academy (INSA) Medal for Young Scientists, and Dr. Vikram Sarabhai Research Award. He is a co-recipient of Best Paper Awards from the 5th IEEE International Workshop on Parallel and Distributed Real-Time Systems (WPDRTS), the 6th and 11th IEEE Annual International Conference on High Performance Computing (HiPC), and the 14th IEEE International Conference on Networks (ICON). He is a Fellow of the Indian National Academy of Engineering, an Associate Editor of IEEE Transactions on Computers, and a Subject Area Editor of Journal of Parallel and Distributed Computing.